

1

Setting Up Your Monitor



The AppleVision 850 and AppleVision 850AV are two-page, Trinitron® color monitors with a diagonal viewable image size of 19.0 inches. Both monitors support a variety of resolutions and feature advanced controls for accurate color rendering. The monitors work with Mac OS–based and Windows-based computers. The AppleVision 850AV includes an integrated audio system consisting of built-in speakers and microphone.

This chapter reviews important safety information and explains how to set up and connect your monitor to your computer. If you purchased a new computer along with your monitor, refer to the setup instructions that came with your computer in addition to the instructions in this manual.

Important safety and cleaning instructions

WARNING Do not clean your monitor screen with a cleaner that contains alcohol or acetone. You might damage the screen. For more information about cleaning your monitor, see “Care and Cleaning” in Chapter 5.

For your own safety and that of your equipment, always take the following precautions.

Disconnect the monitor's power plug (by pulling the plug, not the cord) if any of the following conditions exists:

- the power cord or plug becomes frayed or otherwise damaged
- you spill something into the case
- your monitor is exposed to rain or any other excess moisture
- your monitor has been dropped or the case has been otherwise damaged
- you suspect that your monitor needs service or repair
- you want to clean the case (use only the recommended procedure described in “Care and Cleaning” in Chapter 5)

IMPORTANT The only way to disconnect power completely is to unplug the monitor's power cord. Make sure at least one end of the power cord is within easy reach so that you can unplug the monitor when you need to.

Be sure that you always:

- Keep your monitor away from sources of liquids, such as washbasins, bathtubs, shower stalls, beverages, and so on.
- Avoid setting anything on top of the monitor (such as a book or cup). The monitor could overheat and be damaged.
- Keep the monitor's vents free from obstruction.
- Protect your monitor from dampness or wet weather, such as rain, snow, and so on.
- Read all the installation instructions carefully before you plug your monitor into a power source.
- Keep these instructions handy for reference by you and others.
- Follow all instructions and warnings dealing with your system.

WARNING Never remove the cover from the monitor or you may come in contact with hazardous voltage levels capable of causing serious injury and possibly death.

WARNING Electrical equipment may be hazardous if misused. Operation of this product, or similar products, must always be supervised by an adult. Do not allow children access to the interior of any electrical product, and do not permit them to handle any cables.

What about electromagnetic emissions?

There has been recent public discussion of the possible health effects of prolonged exposure to extremely low frequency (ELF) and very low frequency (VLF) electromagnetic fields. Such fields are associated with electromagnetic sources such as television sets, electrical wiring, and some household appliances—as well as computer monitors.

Apple has reviewed scientific reports and sought the counsel of government regulatory agencies and respected health organizations. Based on the prevailing evidence and opinions, Apple believes that the electric and magnetic fields produced by computer monitors do not pose a health risk.

In response to those customers who wish to reduce their exposure to electromagnetic fields, Apple has lowered the emission levels of Apple monitors. We are also actively encouraging further scientific research so we can continue to promote the health and safety of our customers and employees.

Getting ready to set up your AppleVision 850AV Display

Before you set up your monitor, make sure you have easy access to the following items that came with your AppleVision 850AV Display:

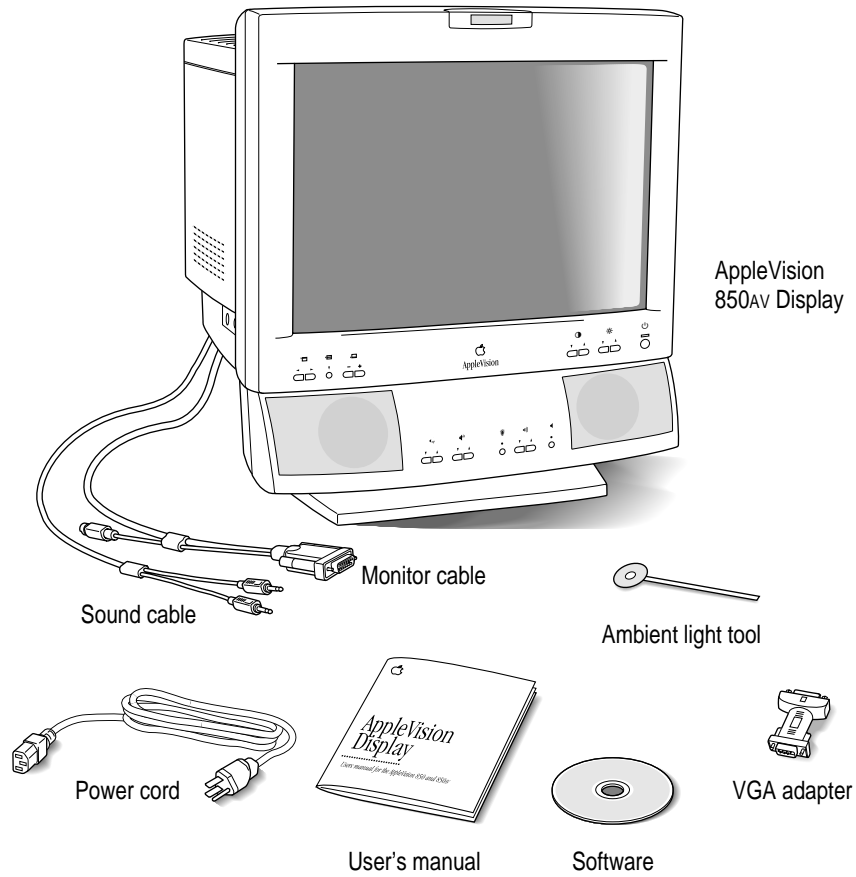

Note: Your power cord may look different from the one pictured.

Your AppleVision 850AV Display at a glance

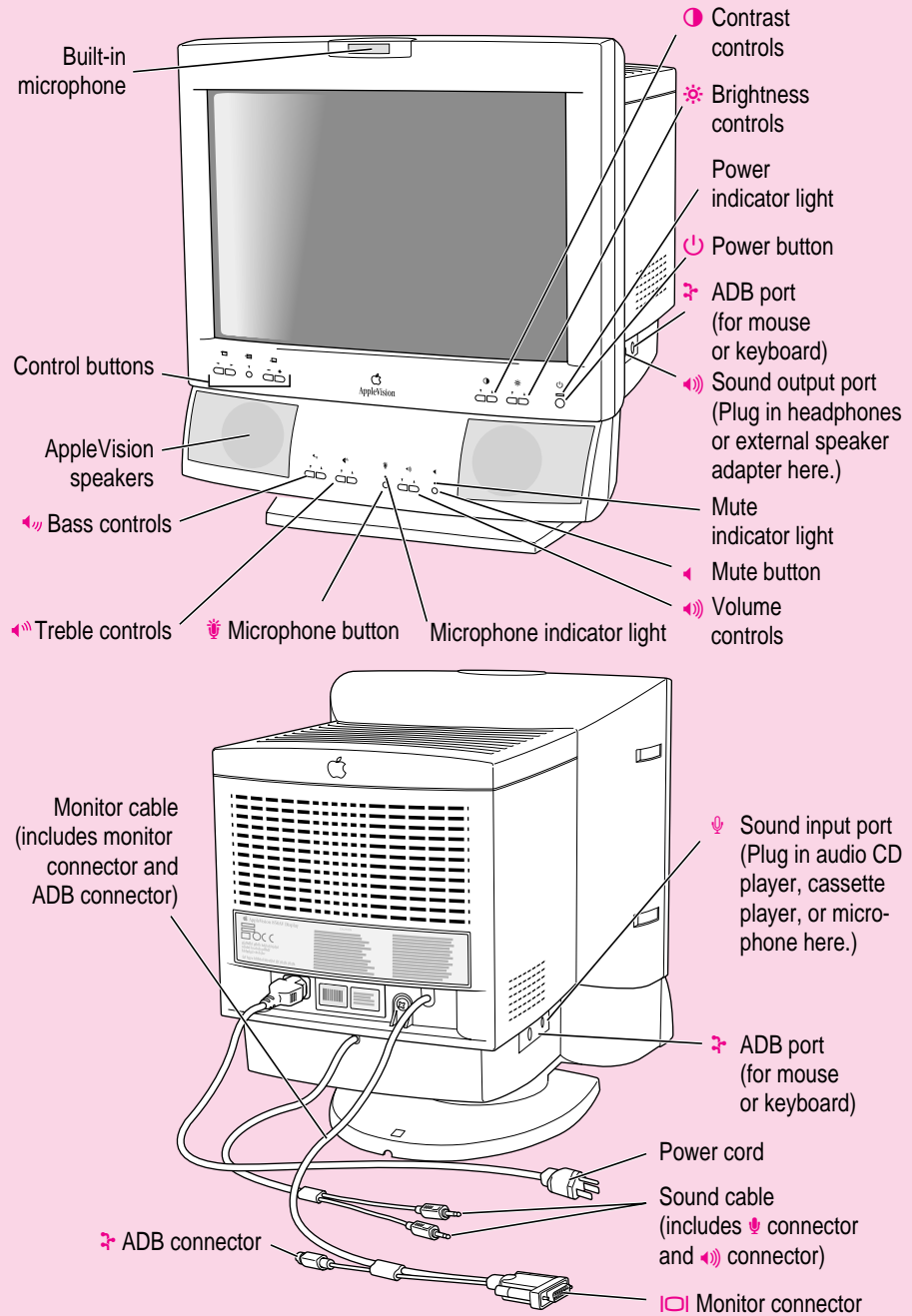

Getting ready to set up your AppleVision 850 Display

Before you set up your monitor, make sure you have easy access to the following items that came with your AppleVision 850 Display:

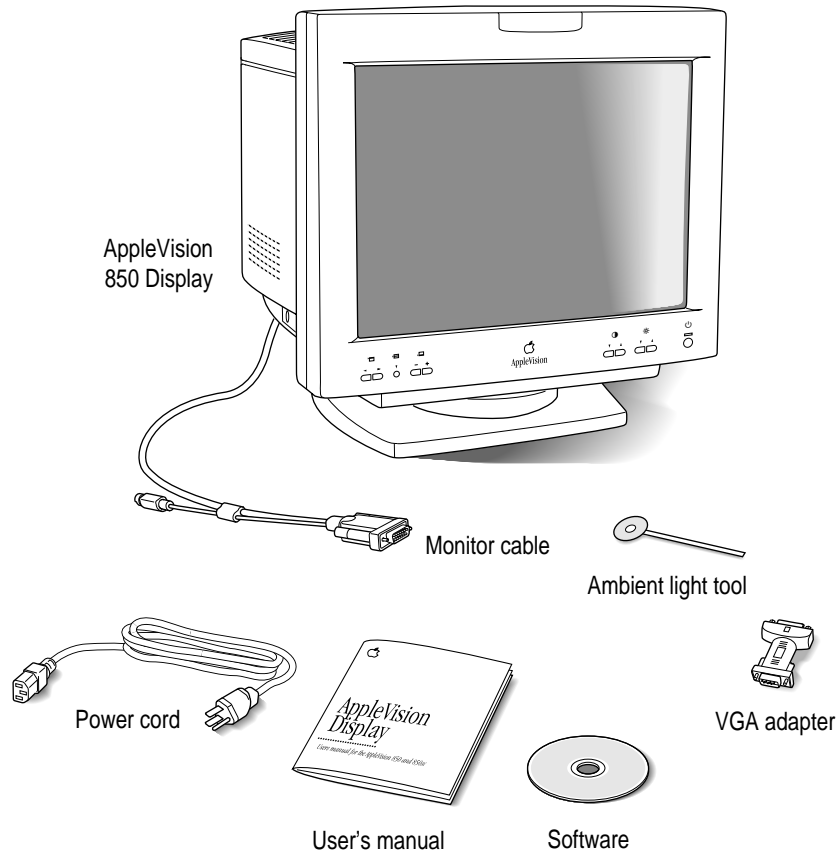

Note: Your power cord may look different from the one pictured.

Your AppleVision 850 Display at a glance

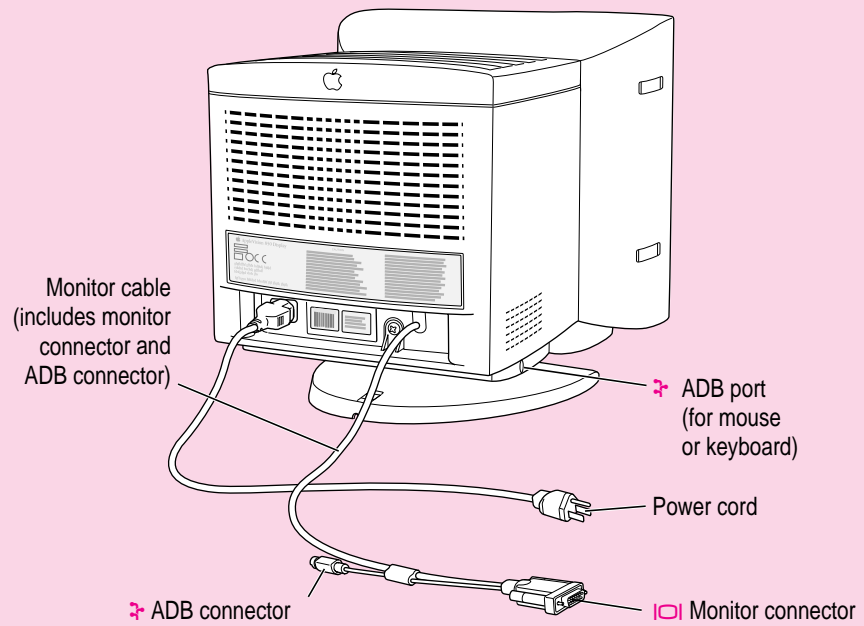
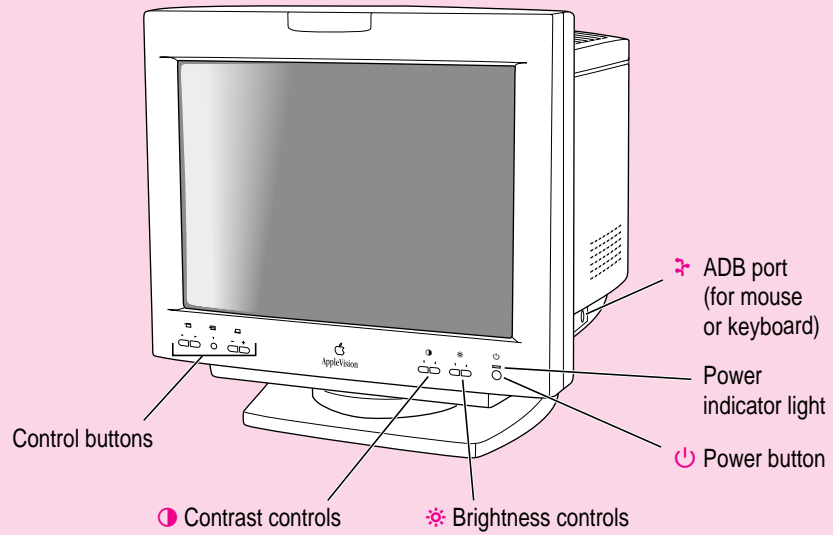

Do you need to install a video card?

The monitor is preadjusted and supports the following scan ranges:

- horizontal scan rate of 30–94 kilohertz
- vertical refresh rate of 48–120 hertz

In addition, the monitor works at the following VESA (Video Electronics Standards Association) standard modes:

Resolution	Vertical refresh rate (hertz)
640 x 480	60-85
800 x 600	56-85
1024 x 768	60-85
1280 x 1024	75-85
1600 x 1200	75

The monitor also works at the following Macintosh standard modes:

Resolution	Vertical refresh rate (hertz)
832 x 624	75
1152 x 870	75

These are preassigned resolutions; your computer may support other resolutions within this range. See the manual that came with your computer or video card to determine which resolutions are supported.

For more information on factory preadjusted settings and other technical information about your monitor, see Appendix B, “Technical Information.”

To use your monitor, you need compatible video circuitry built into your computer or a compatible video card installed in your computer.

Note: The Apple 8•24, Apple 8•24GC, and most NuBus™ video cards are not compatible with your monitor. In addition, some third-party PCI cards are not fully compatible with your monitor.

Mac OS–based computers

If you are not sure whether your computer has appropriate built-in video capability, check with an Apple-authorized dealer or service provider. If your computer does not have the video capability necessary to use your monitor, you need to purchase a video card. (Video cards for Mac OS–based computers are available from an Apple-authorized dealer or service provider.)

Install the video card before you connect the monitor to your computer. To install a video card in one of the expansion slots inside your computer, see the manual that came with your computer or video card.

Windows-based computers

Your monitor works with most Windows-based computers equipped with VGA (Video Graphics Array) or greater capability. You may need to install a video card to use the monitor with your computer. For more information, see the manuals that came with your computer.

If you don't use a preassigned resolution, you'll need to adjust screen geometry to match the new resolution. For more information, see "Adjusting Screen Geometry" in Chapter 4.

Choosing a good location for your monitor

Here are some key factors to consider when determining where to place your monitor:

- Be sure that the desk or table can support the monitor's weight—approximately 67 pounds (30 kilograms) for the AppleVision 850 Display and approximately 77 pounds (35 kilograms) for the AppleVision 850AV Display.
- Make sure that the power cord and monitor cable will easily reach from the back of the monitor to your computer and wall outlet.
- The monitor cable should be unobstructed when you swivel and tilt the monitor, so allow at least 7 inches (17.5 cm) of clearance in the back. If you don't allow enough clearance, the monitor connector might be damaged when the cable hits an obstruction.

Positioning the monitor

IMPORTANT When you unpack or move the monitor, don't set the monitor down at an angle; you might damage the monitor stand.

Once your monitor is in place on a desk or table, follow these steps:

- 1 Place the monitor so the screen faces the user.**
- 2 To slide the monitor, lift the front up slightly and push or pull in the direction you want.**
- 3 Adjust the viewing angle of the monitor by tilting it up or down and turning it left or right on its stand.**

Position the monitor so that when you use it, no bright light is behind the monitor or reflected on the screen. Your eyes should be about level with the top edge of the screen and between 18 and 28 inches (45 to 70 cm) away. Take occasional breaks when using your computer to focus your eyes on a distant object.

For your greatest comfort, use the following illustration to help you in positioning your monitor.

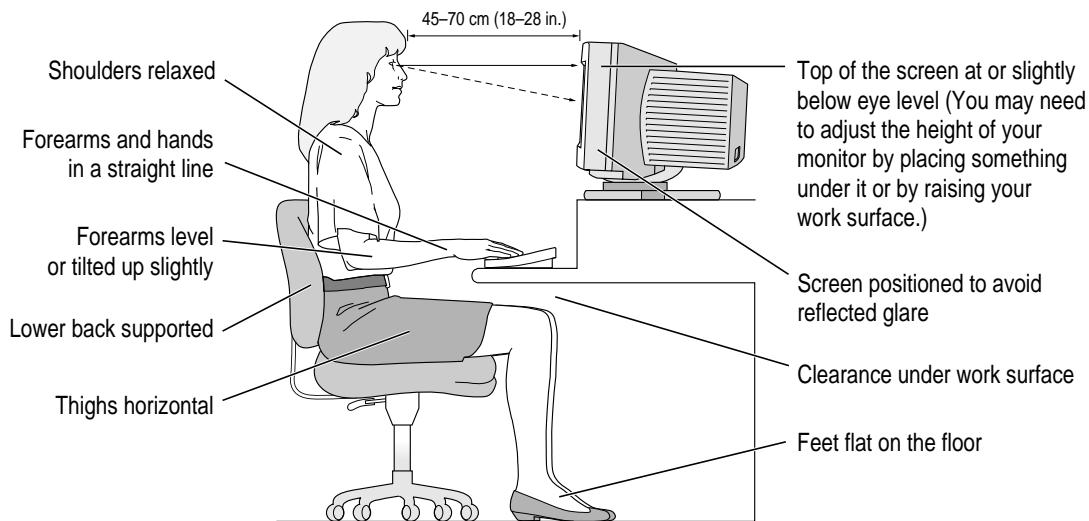

Note: After you set up and configure the monitor, adjust the image and colors on the screen to match your environment. For example, in a bright room, contrast is usually best set at maximum; in a dim room, lower contrast is usually more comfortable. See Chapter 2, “Installing and Using AppleVision Software,” for more information about making screen and color adjustments using AppleVision software for Mac OS–based computers. See Chapter 4, “Using Your Monitor With Windows-Based Computers,” for information about onscreen controls for adjusting screen image and color for Windows-based computers.

Connecting the monitor to your computer

Follow these steps to connect your AppleVision 850 or 850AV to your computer.

Note: Although the AppleVision 850AV is shown in the illustrations, setup is the same for the AppleVision 850, unless noted.

IMPORTANT Before you connect any cords or cables, make sure your computer is turned off.

WARNING This equipment is intended to be electrically grounded. Your monitor may be equipped with a three-wire grounding plug—a plug that has a third (grounding) pin. This plug will fit only a grounded AC outlet. This is a safety feature. If you are unable to insert the plug into the outlet because the outlet is not grounded, contact a licensed electrician to replace the outlet with a properly grounded outlet. Do not defeat the purpose of the grounding plug!

Connecting the power cord

- 1 Connect the socket end of the power cord to the power cord receptacle on the back of the monitor.

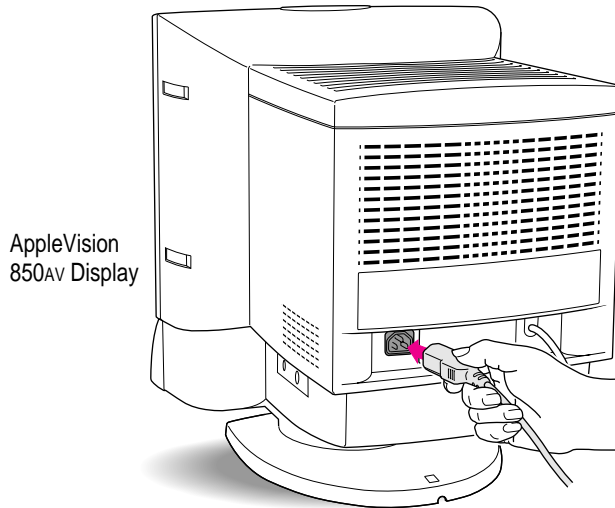

- 2 Plug the other end of the power cord into a grounded outlet or power strip.

Note: You may have a power jumper cord instead of a power wall cord. In this case, plug the power jumper cord into the power socket on the back of your computer.

Connecting the monitor cable to a Mac OS–based computer

Connecting to a standard monitor port

To realize the full capability of your monitor, you must connect it to the video *and* ADB ports on your computer. The monitor cable is a split cable with two connectors, one for video and one for the Apple Desktop Bus (ADB).

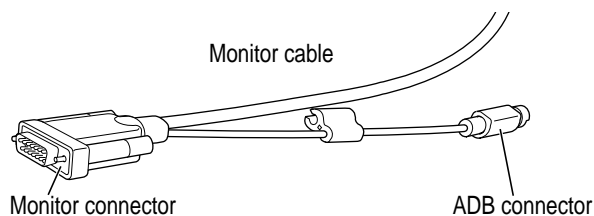

- 1 **Plug the monitor connector on the monitor cable into the monitor port (marked by ) on the back of your computer.**

If your computer has more than one monitor port, see the manual that came with your computer for information on choosing the correct port.

If you installed a video card in your computer, connect the monitor connector on the monitor cable to the video card's port. For more information about installing video cards, see the manual that came with your computer or video card.

- 2 **Tighten the thumbscrews on the connection.**



You can prevent bad connections and accidental damage by tightening the thumbscrews. Do not overtighten the thumbscrews; you might strip the threads.

- 3 **Plug the ADB connector on the monitor cable into an ADB port (marked by ) on the back of your computer.**

Make sure the ADB connector is attached firmly.

IMPORTANT The ADB connector is not optional; it's needed for your Mac OS–based computer to work correctly with your monitor. If not connected properly, extended resolutions and AppleVision software controls will not be available.

If you have only one ADB port on the back of your computer and you're already using it for your keyboard and mouse, unplug the keyboard and mouse and connect them directly to your AppleVision monitor. For more information, see “Connecting a Mac OS–Based Computer Keyboard and Mouse to Your Monitor” later in this chapter.

WARNING Make sure you don't plug the ADB connector into an S-video port (marked by  or ) by mistake. The ports are the same size, and it's easy to mistake one for the other. It may cause electrical damage to your computer or monitor.

IMPORTANT When connecting ADB cables, be sure to align the symbol  on the connector with the same symbol on the port. If you force a connector the wrong way, you will damage it.

Connecting the monitor cable to various video connectors

To connect the monitor to a high-density port (45-pin port) instead of a standard monitor port (15-pin port), you need to use an adapter. This adapter is usually provided with your computer. If you don't have one, you can purchase an adapter (Apple part number 590-0337) from an Apple-authorized dealer.

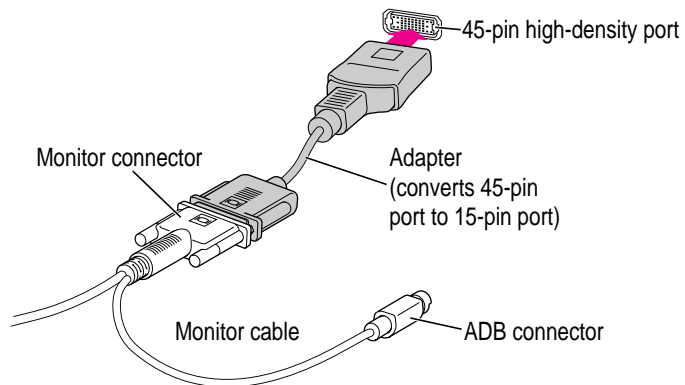

Other video connectors, such as PowerBook adapters, can also connect to your monitor port with special adapters. For more information, see the manual that came with your computer.

Note: If your Mac OS–based computer came with a VGA adapter for connecting monitors, use it instead of the one shipped with your AppleVision monitor.

Connecting the monitor cable to a Windows-based computer

Although the monitor cable is a split cable with two connectors, you will use only the monitor connector with your computer.

- 1 Connect the VGA adapter to the monitor connector (marked by ) on the monitor cable.**

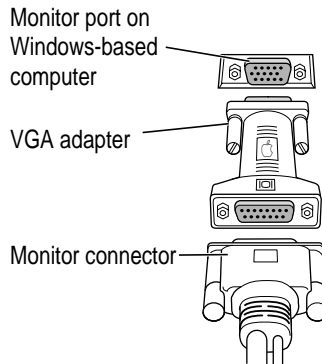

- 2 Tighten the thumbscrews on the connection.**

You can prevent bad connections and accidental damage by tightening the thumbscrews. Do not overtighten the thumbscrews; you might strip the threads.

- 3 Connect the VGA adapter end of the monitor cable to the monitor port on the back of your computer.**

If you installed a video card in your computer, connect the monitor cable (with the VGA adapter attached to it) to the video card's port. For more information about installing video cards, see the manual that came with your computer or video card.

- 4 Tighten the thumbscrews on the connection.**
- 5 Leave the ADB connector on the monitor cable unplugged.**

The ADB connector is for Mac OS–based computers only. Use the clip on the monitor cable to move the connector out of the way.

Connecting a Mac OS–based computer keyboard and mouse to your monitor

If you wish, you can plug your keyboard and mouse directly into the monitor, rather than into the back of your computer. There is one ADB port on each side of the monitor for your keyboard and mouse (or any other ADB device).

IMPORTANT Always be sure your computer is shut down before you plug in or disconnect ADB cables.

- 1 Make sure the ADB connector on the monitor cable is plugged into an ADB port (marked by ⌘) on the back of your computer.**

IMPORTANT The ADB connector is not optional; it's needed for your Mac OS–based computer to work correctly with your monitor. If not connected properly, extended resolutions and AppleVision software controls will not be available.

For more information, see “Connecting the Monitor Cable to a Mac OS–Based Computer” earlier in this chapter.

- 2 If necessary, unplug the keyboard or mouse cable from the ADB connector on the back of your computer.**
- 3 Decide how you want to connect the keyboard and mouse.**

For example, you can connect your mouse cable to your keyboard and then connect the keyboard to one of the ADB ports (marked by ⌘) on either side of the monitor stand. Or, if you prefer, you can plug your keyboard and mouse cables into the ADB ports (marked by ⌘) on either side of the monitor stand.

- 4 Connect your keyboard and mouse cables to the monitor's ADB ports (marked by ⌘) according to your preference.**

Connecting sound equipment to your AppleVision 850AV Display

Connecting the sound cable

The sound cable on your monitor is a split cable with two connectors, one for sound input (such as a microphone or audio CD) and one for sound output (such as a speaker).

Plug these connectors into your computer to use the built-in microphone and speakers on your AppleVision 850AV Display. (This feature is not available on the AppleVision 850 Display.)

- 1 Plug the connector (marked by 🎧) on the sound cable into the sound input port on your computer.**

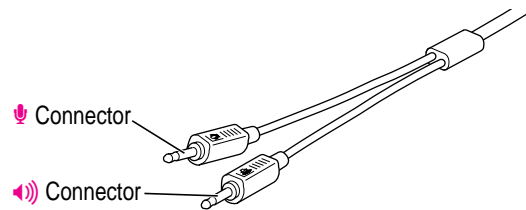

For Mac OS–based computers, the port (marked by 🎧) is on the back of the computer. For Windows-based computers, the connector (marked by 🎧) fits most standard microphone jacks. The sound input port on a Windows-based computer may be located on a sound or multimedia card.

On some Windows-based computers, the connector (marked by 🎧) on the sound cable should only be plugged into the line level input port of your sound card. See the documentation that came with your sound card to determine where the appropriate line level input port is located.

- 2 Plug the connector (marked by 🔊) on the sound cable into the sound output port on your computer.**

For Mac OS–based computers, the port (marked by 🔊) is on the back of the computer. For Windows-based computers, the connector (marked by 🔊) fits most standard speaker jacks. The sound output port on a Windows-based computer may be located on a sound or multimedia card.

Connecting external sound equipment

The AppleVision 850AV Display has two sound ports you can use to connect external sound equipment. The port on the left side of the monitor is for connecting sound input equipment (such as an audio CD player, cassette player, or microphone). The port on the right side of the monitor is for connecting sound output equipment (such as headphones or external speakers).

The monitor's sound output port (marked by ) accepts a connector known as a *stereo miniplug*. This connector is the type used on headphones for most CD and cassette players.

The monitor's sound input port (marked by ) accepts both the stereo miniplug connector and an extended version of the miniplug. The extended miniplug is slightly longer and is found on voice-quality microphones such as the Apple PlainTalk Microphone.

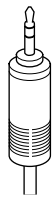

Stereo miniplug

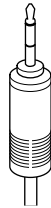

Extended miniplug

If your equipment has a different type of connector, you can purchase an adapter at an electronics supply store.

Connecting sound input equipment

To record sound, you can use the built-in microphone on your AppleVision 850AV Display, or you can connect external sound input equipment (such as an audio CD player, cassette player, or external microphone) to the monitor.

To connect sound input equipment:

- 1 Make sure the connector (marked by 🎧) on the sound cable is plugged into the sound input port on your computer.**

For most computers, the port (marked by 🎧 on Mac OS–based computers) is on the back of the computer.

- 2 Plug the sound input equipment into the sound input port (marked by 🎧) on the left side of the monitor.**

Note: To use sound input equipment (such as an audio CD player, cassette player, or external microphone), you must select the correct sound input source. For Mac OS–based computers, use the Monitors & Sound control panel. For Windows-based computers, press and release the microphone button on the front panel of the monitor to switch between the built-in microphone and the monitor’s sound input port, or see the manual that came with your computer.

Connecting sound output equipment

If you wish, you can plug a pair of headphones (or other sound output equipment) into the AppleVision 850AV Display.

To plug headphones into the monitor, follow these steps:

- 1 Make sure the connector (marked by 🎧) on the sound cable is plugged into the sound output port on your computer.**

For most computers, the port (marked by 🎧 on Mac OS–based computers) is on the back of the computer.

- 2 Plug the headphones into the sound output port (marked by 🎧) on the right side of the monitor.**

Using more than one monitor

If your computer has expansion slots, you can use your monitor with one or more additional monitors connected to your computer. You may need a video card for each additional monitor you are using. See the manual that came with your computer for more information.

If your Mac OS–based computer has one ADB port, you can still connect two AppleVision monitors. You'll need a special cable to split the ADB connector cable into two parts.

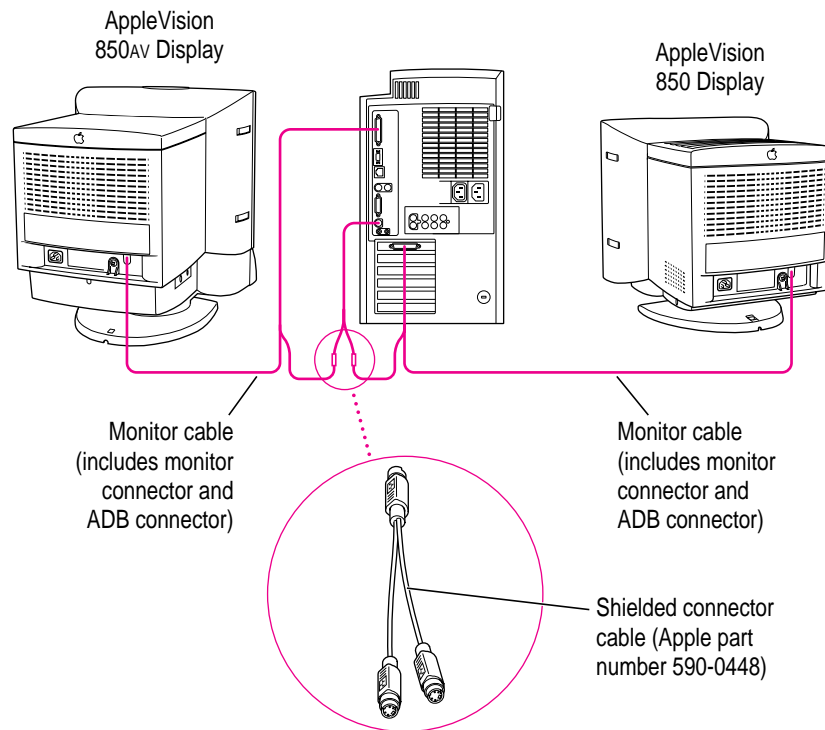

IMPORTANT Make sure you use an Apple *shielded* connector cable. Most third-party ADB splitter cables are not shielded and will not work properly with your AppleVision monitor. (You may experience more radio interference with an unshielded connector cable.)

Turning the monitor on

To turn on the monitor for the first time:

- 1 Plug in the computer's power cord.**
- 2 Press the power button on the monitor.**

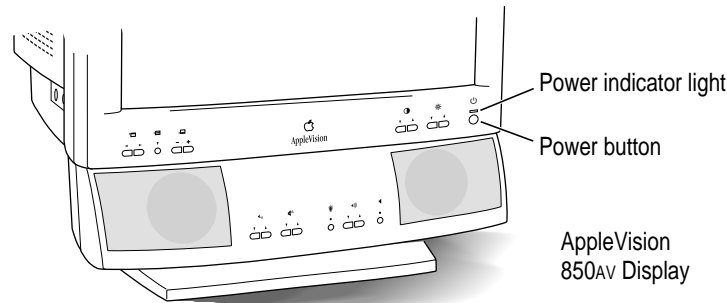

If you plug your monitor directly into your computer, no power indicator light goes on until you start up your computer. If you plug your monitor into a wall outlet, the monitor's amber power indicator light goes on. When you start up your computer, the indicator light turns green.

- 3 Start up your computer and wait a few seconds.**

The green power indicator light goes on. If the power indicator light does not go on, press the monitor's power button again. If this doesn't work, make sure you've connected the monitor cable and power cord properly. (See "Connecting the Monitor to Your Computer" earlier in this chapter.) Also, make sure your computer is turned on and no energy-saving or screen-saving features are active. The power indicator light on the monitor is amber when an energy-saving program is on.

For Mac OS–based computers, you must first install the AppleVision software that came with your monitor *before* adjusting the screen with the front panel buttons and using other monitor features. For more information on AppleVision software installation and Energy Saver, see Chapter 2, “Installing and Using AppleVision Software.”

WARNING Before making any screen or sound adjustments, install the AppleVision software on your Mac OS–based computer. Using software other than the new AppleVision software that came with your monitor could damage your monitor.

Using the monitor with Windows-based computers

In most cases, once you turn on the monitor, you will not have to make any adjustments to the screen image. If necessary, you can adjust or fine-tune the image to suit your personal preference. For more information about adjusting the screen image, see Chapter 4, “Using Your Monitor With Windows-Based Computers.”

To change resolutions on your monitor, see the manuals that came with your operating software or video card.

Note: The *AppleVision Software* CD-ROM disc includes AppleVision setup information for Windows 95 users. See Chapter 4, “Using Your Monitor With Windows-Based Computers,” for installation instructions.

Finding answers

When you have questions about using your monitor, there are several places you can look for answers.



This manual

Use this manual to set up your monitor, install AppleVision software for Mac OS–based computers, install AppleVision setup information and use onscreen controls for Windows-based computers, and find solutions to common problems.



Apple Guide for Mac OS–based computers

If you need help or experience a problem while using the AppleVision software, open the Guide (Ⓜ) menu and choose Macintosh (or Mac OS) Guide or Monitors & Sound Guide. The Guide menu is the main source for information about the AppleVision software and your Mac OS–based computer. See Chapter 2 for more information.



Monitors & Sound doc.pdf

AppleVision software instructions for System 7.1 users

If you're using System 7.1, Apple Guide isn't available. Instead, open the Monitors & Sound doc.pdf file using Adobe Acrobat Reader to view AppleVision software instructions. See Chapter 2 for more information.

Obtaining online support and updated Apple software

Apple technical support information and software updates are available from many online services. You can get troubleshooting and other important information by using these services. You can also get the latest versions of Apple software, including most printer drivers, system enablers, and updates to utilities and networking and communications software.

Support information and Apple software updates are available via Apple's World Wide Web sites:

- <http://www.info.apple.com>
- <http://www.support.apple.com>

What to do next

Mac OS–based computers

Go to the next chapter for information about installing and using AppleVision software.

Windows-based computers

Go to Chapter 4, “Using Your Monitor With Windows-Based Computers,” for information on installing AppleVision setup information and using the control buttons to open onscreen menus for screen image and sound adjustments.



2

Installing and Using AppleVision Software



This chapter explains how to install AppleVision software on your Mac OS–based computer and provides an overview of software features. If you’re using the monitor with a Windows-based computer, see Chapter 4, “Using Your Monitor With Windows-Based Computers.”

Installing AppleVision software

To install AppleVision software on a Mac OS–based computer, follow these steps:

1 Make sure you have System 7.1 or later installed.

You need a Mac OS–based computer running System 7.1 or later to use the software. If you don’t have System 7.1 or later, contact an Apple-authorized dealer or service provider.

Note: You must connect your monitor to a computer with a 68040 processor or PowerPC™. The monitor does not work with computers that have been upgraded to a 68040 processor from earlier processors, such as a 68030 processor.

2 Insert the *AppleVision Software* CD-ROM disc into the computer’s CD-ROM drive.

The CD icon appears on the desktop.

Note: If you don’t have a CD-ROM disc drive, you can order a set of floppy disks of the AppleVision software. See the service and support information that came with your monitor for more information.

- 3 Double-click the CD icon to see what's on the CD-ROM disc.**

The AppleVision Software CD window opens.

- 4 Double-click the folder that contains your language preference.**

For example, if you'd like to install AppleVision software in English, double-click the English folder.

- 5 Double-click the AppleVision Software folder.**

- 6 Double-click the AppleVision Read Me file and read the document.**

The AppleVision Read Me file contains important information about the applications included with your AppleVision software. It also provides a list of installed software for your reference.

- 7 Choose Quit from the File menu when you're finished reading.**

- 8 Double-click the AppleVision Installer icon to start the Installer program.**

A welcome screen appears.

- 9 Click Continue.**

The software license agreement dialog box appears.

Note: Be sure you're acting within the terms of the software license agreement before you agree to install this software on your computer. The license agreement specifies how many copies of the program you can make for yourself and others.

- 10 **Click Agree once you've read and agreed to the terms in the document.**

The Install AppleVision Software dialog box appears. The software version number shown on your screen might be different from the one illustrated here.

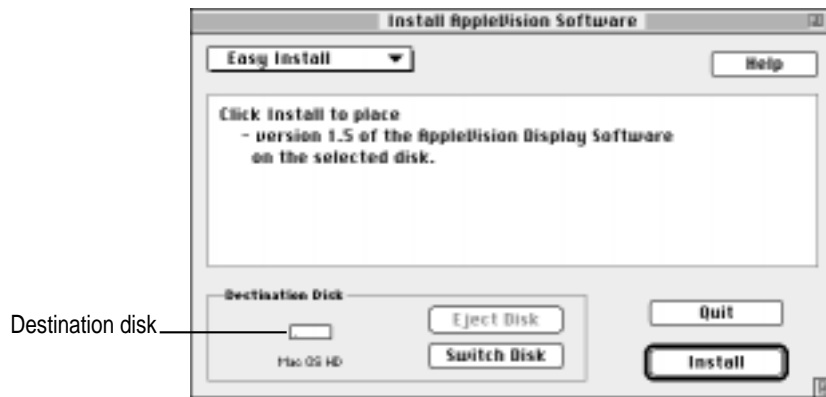

- 11 **Make sure the destination disk named is the startup disk of your computer. If it isn't, click Switch Disk until you see the right name.**
- 12 **Select Easy Install; then, click Install.**

The Installer takes a few minutes to calculate what needs to be done and then begins to copy files. If you are running other applications, a message appears telling you to quit any open applications. Click Continue to quit the applications and continue with the installation.

Note: Make sure you use the Installer to install the software. Do not install the software by dragging files.

- 13 **Follow the instructions on the screen until the installation is complete.**

IMPORTANT The Installer checks to make sure you have the system software you need to use the monitor. If you're missing anything, a message tells you what you need. You won't be able to install the software until you correct the problem. If a dialog box says you don't have the correct system software, you can purchase a new version from an Apple-authorized dealer.

After the installation, the Installer tells you to restart your computer.

- 14 **Click Restart.**

The software is now installed and the monitor is ready for use.

IMPORTANT If you reinstall system software on your computer, you must reinstall the AppleVision software.

Note: If you press a control button under the screen on the left front of your monitor and do not see the Monitors & Sound control panel, you probably haven't set up your AppleVision monitor correctly. Make sure the ADB connector on the monitor cable is connected directly to your computer's ADB port. See Chapter 1, "Setting Up Your Monitor," for more information.

Learning about AppleVision software with System 7.5 or later

This section explains how to open Monitors & Sound Guide for information about using AppleVision software with your monitor. If you're using System 7.1, see the next section, "Learning About AppleVision Software With System 7.1."

The Monitors & Sound Guide is your main source of information about AppleVision software. The Guide menu is identified by a question mark (Ⓜ) in the upper-right corner of the screen.

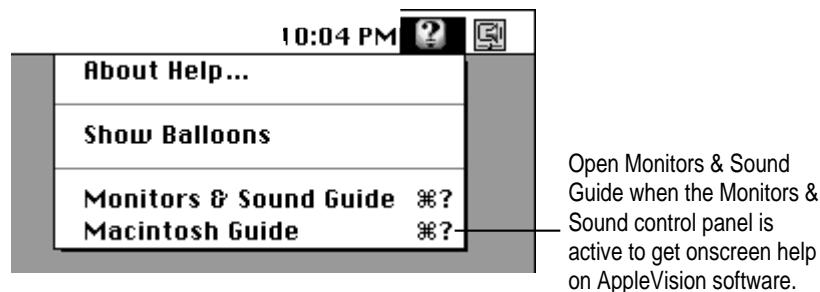

To open Monitors & Sound Guide, make sure your Monitors & Sound control panel is active. Then, click the Guide (Ⓜ) icon on the top right corner of the control panel to open Monitors & Sound Guide or choose Monitors & Sound Guide in the Guide (Ⓜ) menu at the top of your screen.

Macintosh (or Mac OS) Guide also contains the same information about the AppleVision software as well as other information about using your computer. Macintosh Guide is available while you're in the Finder.

Monitors & Sound Guide provides onscreen help on how to use AppleVision software.

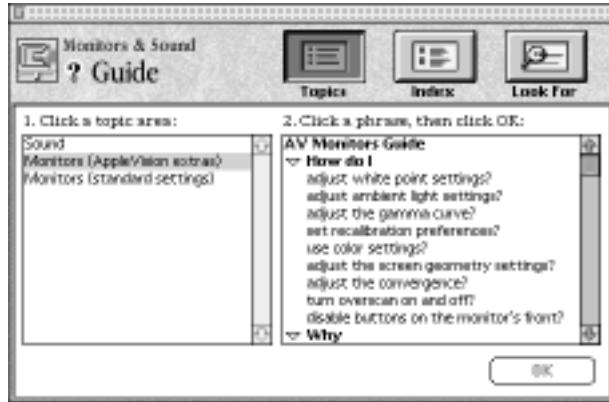

Monitors & Sound Guide provides information about the following topics: sound, monitors (AppleVision extras), monitors (standard settings), and troubleshooting. Click the Topics button to open these topic areas and choose a topic. Then, select a question in the list and click OK to open detailed instructions.

Tips for using Monitors & Sound Guide

When you can't find the information you need

- In searching for help topics, use all three buttons at the top of Guide's initial window: Topics, Index, and Look For.
- If you're in a series of steps and want to return to the list of help topics, click the button marked Topics in the Guide window.

When you can't see what's behind the Guide window

Guide windows stay in front of other windows on the screen so that your instructions are never covered.

- Drag a Guide window by its title bar to move it out of the way.
- Click the zoom box once to shrink a Guide window. (To expand the window, click the zoom box a second time.)

When you need more information about an instruction or term

- Click the “Huh?” button if it is available.
- If an unfamiliar word is underlined, click it to get a definition.

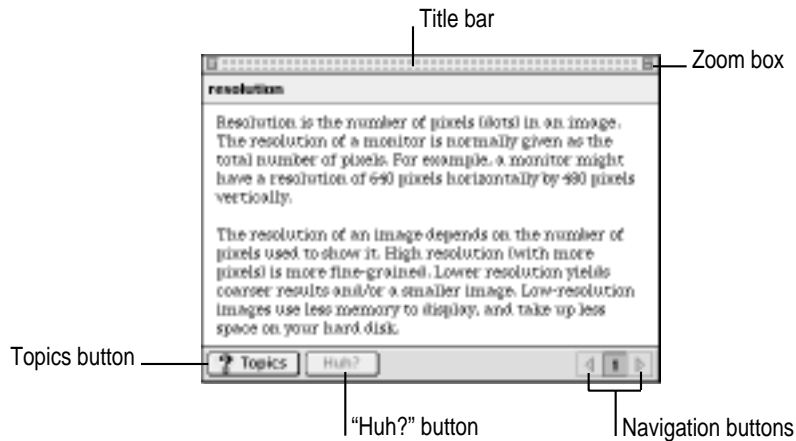

Learning about AppleVision software with System 7.1

Because Monitors & Sound Guide is not available to System 7.1 users, AppleVision software instructions are provided onscreen in a pdf file format. To view the instructions, you must first install Adobe™ Acrobat™ Reader (included on the *AppleVision Software* CD-ROM disc).

To install Adobe Acrobat Reader, follow these steps:

- 1 Insert the *AppleVision Software* CD-ROM disc into the computer's CD-ROM drive.
- 2 If necessary, double-click the CD icon to open the AppleVision Software CD window.
- 3 Double-click the folder that contains your language preference.
- 4 Double-click the Acrobat Reader folder.
- 5 Double-click the ACROREAD.MAC icon to start the Installer program.
- 6 Click Continue in the first dialog box.
- 7 After you've read and agreed to the terms and conditions of the license agreement, click Continue.

- 8 **Make sure that the disk that appears in the Install Location box is the startup disk of your computer; then click Install.**



- 9 **When installation is complete, click Restart in the dialog box that appears.**

You're now ready to use Acrobat Reader to view AppleVision software instructions.

- 10 **Go to the Apple Extras folder on your hard disk and double-click the folder; then double-click the AppleVision Extras folder to view its contents.**

Double-click Monitors & Sound doc.pdf to view AppleVision software instructions using Acrobat Reader.

For more information about Adobe Acrobat Reader, see the ReadMe-Reader2.1 file in the Acrobat Reader folder installed on your hard disk.

Screen controls at a glance

The buttons on the front of your monitor provide a quick way to adjust the screen image. In most cases, you won't need to adjust the screen image unless you make changes to screen resolution.

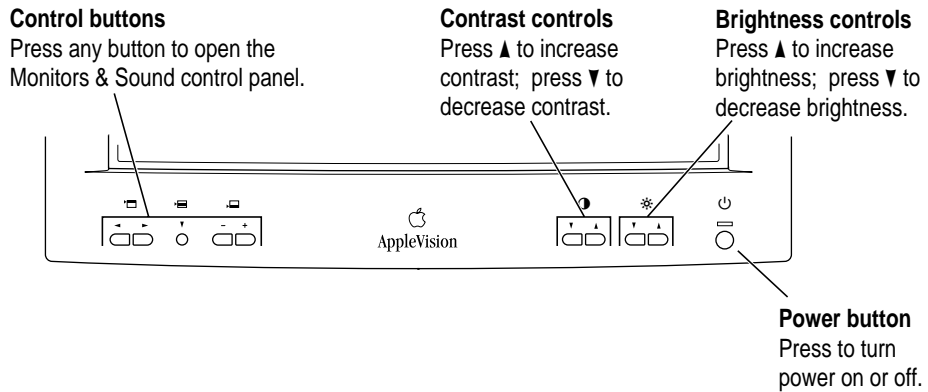

The Contrast and Brightness adjustments have an onscreen indicator that appears when you press a button on the front of your monitor. For example, pressing a Brightness button displays the Brightness indicator.

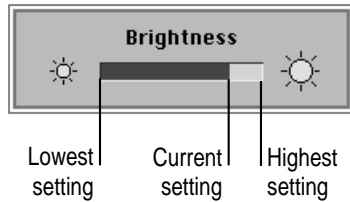

When you make an adjustment, the indicator bar moves to show the current setting. When you've finished making adjustments, the indicator disappears automatically.

About the Monitors & Sound control panel

The Monitors & Sound control panel allows you to control the way your computer displays images and processes sound. Because different computers have different capabilities, Monitors & Sound automatically adjusts itself based on the video and sound capabilities of the computer and monitor you're using. That's why the Monitors & Sound control panel shown in this manual may appear slightly different on your computer.

If you have more than one monitor attached to your computer, a separate Monitors & Sound control panel will appear on each one, allowing you to customize your settings for each monitor separately.

Opening Monitors & Sound

There are two ways to open the Monitors & Sound control panel:





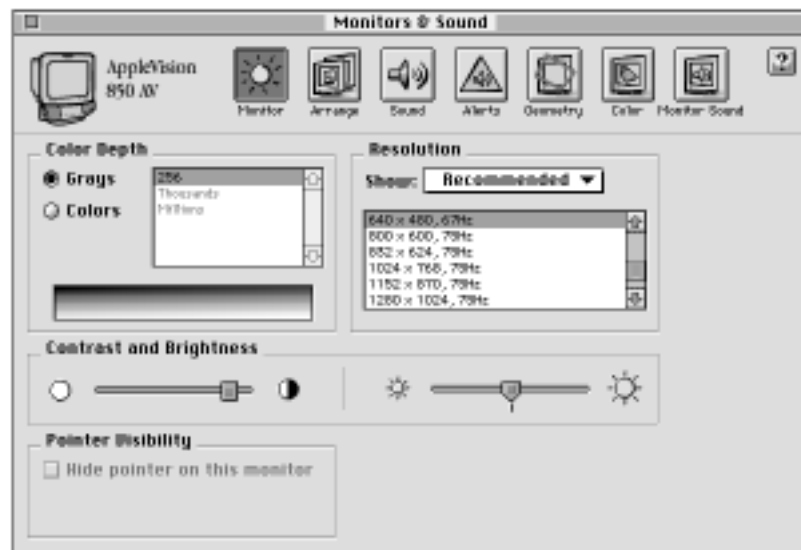

- Choose Control Panels from the Apple () menu; then select Monitors & Sound.
- Press one of the control buttons under the screen on the left front of your AppleVision monitor.

After a moment, the Monitors & Sound control panel appears on your screen.



Monitors & Sound buttons at a glance

The large buttons across the top of the Monitors & Sound control panel are used to select different options. See *Monitors & Sound Guide* or the *Monitors & Sound doc.pdf* file for detailed information on using the AppleVision software.

Button	Description
	Use the Monitor button to adjust color depth, resolution, contrast, and brightness settings.
	Use the Arrange button to configure more than one monitor. This button appears on your screen if you have more than one video port on your computer.
	Use the Sound button to adjust your computer system's sound. You can also set the volume and balance for speakers attached to your computer, choose sound input devices such as a microphone or CD player, and select sound output quality.
	Use the Alerts button to change your computer's alert sound.
	Use the Geometry button to change the image options for your monitor. You can change the size and shape of the screen image, adjust convergence, and turn overscan on and off.
	Use the Color button to change color calibration, gamma curve, white point, and ambient light settings, and to import or export a ColorSync profile. (For more information on ColorSync, see Appendix A.)
	Use the Monitor Sound button to control the monitor's internal speakers and devices connected to your AppleVision 850AV Display. (These features are not available on the AppleVision 850 Display.)

Tips for using AppleVision software

- For best results, recalibrate your monitor after changing the color settings. For example, color adjustment changes don't take effect until you click Recalibrate. You can choose to have your monitor recalibrate automatically whenever you change the settings. Click the Color button. Then click Preferences. After selecting your recalibration preferences, click Save.
- To use the default settings shipped with your monitor, click the Geometry button. When the Geometry window opens, click the Factory Settings option. To use the color default settings, click the Color button. When the Color window opens, double-click Factory Defaults in the Saved Settings menu.
- Red, green, and blue signals in your monitor overlay, or converge, to create the colors you see on your screen. If the convergence is not set properly, images or text on your screen may appear blurred, or you may get a “rainbow” effect in which several colors form the edges of images on the screen. If you move your monitor to another location, you may need to change the convergence to get a clear, distinct screen image. To adjust convergence, click the Convergence button in the Geometry window.
- When overscan is on, you may not be able to choose commands from the menus at the top of your monitor. If this occurs, you can't use a menu to open the Monitors & Sound control panel and turn overscan off. Instead, open Monitors & Sound by pressing a Control button on the front of your monitor.
- The ColorSync profile included with your monitor works with other device profiles to ensure the closest match possible between monitor color and printed color. See “Using ColorSync” in Appendix A for more information. To refine the color profile, you can use the Color window in Monitors & Sound to further adjust for your specific monitor and lighting conditions.
- To correct for ambient light conditions, you must set the color depth on your monitor to Millions of Colors. If you can't set color depth to Millions of Colors, try changing to a lower screen resolution. Use the Color button to open color depth and resolution settings.

Using the Control Strip

When you turn on your monitor, a small pull tab appears in the lower-left corner of the screen. Click once on the pull tab to open it. This is called the *Control Strip*.

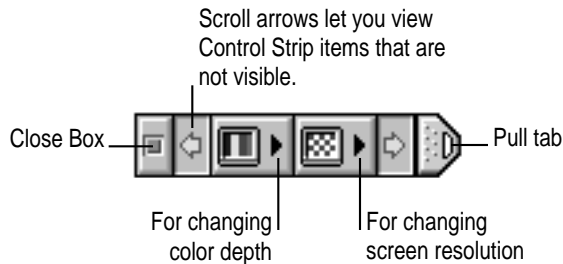

The Control Strip is a quick and easy way to make changes to the features you use most on your computer, such as screen resolution and color depth.

The Control Strip may look slightly different depending on the options on your computer. Move the pointer over the item you want to use and hold down the mouse button. A pop-up menu appears with a selection of choices.

Hold down the Option key and drag the Control Strip up or down the left or right side of the desktop. Release the Option key and mouse button when the Control Strip is located where you want it.

Using DigitalColor Meter

DigitalColor Meter and your monitor work together to identify colors on your screen based on the standard color gamuts defined by the Commission on Illumination (CIE).

DigitalColor Meter can also identify colors using the Pantone® system. Pantone is a color-matching system used to specify ink colors for high-end printers. Pantone colors are described using their printing ink formulation, which is identified by a specific Pantone number. DigitalColor Meter performs color matching and provides Pantone numbers for coated (CVC), uncoated (UVC), and process (CVP) color samples. Use the Pantone numbers when you have your work professionally printed to ensure that the printer will use colors similar to those displayed on your screen.

Finally, you can use DigitalColor Meter to identify the RGB (red, green, blue) values your computer uses to create colors.

Opening DigitalColor Meter

Choose DigitalColor Meter from the Apple (🍏) menu. (It was installed with your AppleVision software.)

When you launch DigitalColor Meter, its window opens on your monitor.

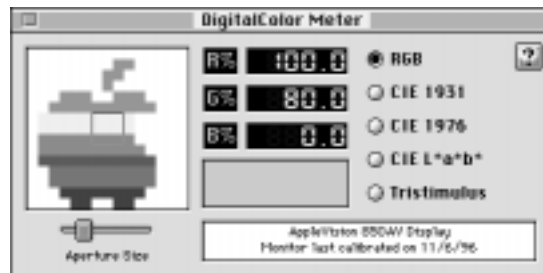

See DigitalColor Meter Guide (located in the Guide [?] menu when the DigitalColor Meter application is active) or the Monitors & Sound doc.pdf file for more information on how to use DigitalColor Meter.

Specifying colors using the Pantone Matching System

In some application programs, you can use Apple Color Picker to specify Pantone colors. The Pantone Color Picker extension is automatically installed along with the rest of the AppleVision software.

For example, in a variety of applications, Apple Color Picker is automatically launched when a new color needs to be specified. Often, a menu of several different color systems is available to choose from. When you select Pantone, a dialog box appears.

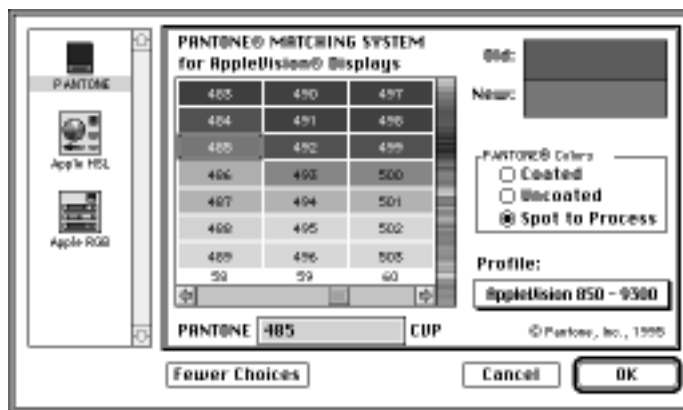

By selecting Pantone matching colors, you are assured of a close match between what you see on your monitor and the printed version. Pantone Color Picker may look different on your computer.

If Pantone colors are not available in the Color Picker menu, click the More Choices button; then select Pantone.

Conserving energy

Use the Energy Saver control panel to tell the monitor whether to conserve energy after a specified period of inactivity.

You can use the control panel with your AppleVision monitor or any other Apple monitor that complies with the United States Environmental Protection Agency's Energy Star program. (Look for the EPA Energy Star logo on the monitor box.)

Note: When you save energy, you save natural resources and reduce pollution. Although the AppleVision 850 and 850AV contain features that automatically save energy, you can increase the energy savings by turning the computer off if you won't be using it for awhile—for example, overnight or over the weekend.

For more information about power-saving and environmental features, see Appendix B.

Setting up Energy Saver

To use the Energy Saver control panel, follow these steps:

- 1 **Choose Control Panels from the Apple () menu.**

If you're using System 7.5, a pop-up menu appears. If you're using System 7.1, a window opens showing all the control panels.

- 2 **Choose Energy Saver or double-click the Energy Saver icon to open the Energy Saver control panel.**

- 3 **Click the Energy Saver icon in the control panel:**

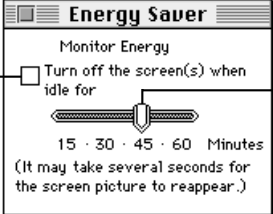

Click to turn Energy Saver on or off. When there's an X in this box, Energy Saver is on.

If Energy Saver is on, slide this control to determine how long Energy Saver will wait without activity before darkening the screen.

IMPORTANT If you've installed the AppleVision software that came with your monitor and the Energy Saver icon still doesn't appear or the Energy Saver control panel doesn't look like the one above, you may have a different type of energy-saving software. In this case, instructions in this section don't apply. See Macintosh (or Mac OS) Guide for instructions on saving energy. To open Macintosh Guide, choose Macintosh Guide from the Guide menu (marked with the  icon) when the Finder is active.

Note: Not all Mac OS-based computers work with Energy Saver. See "Troubleshooting Common Problems" in Chapter 5 for more information.

4 Close the control panel.

IMPORTANT If you use Energy Saver, make sure you turn it off when you're doing disk-intensive tasks such as copying a large number of files, downloading large files from an online service, or printing a very large file. If Energy Saver is activated during a disk-intensive task, the task may be terminated prematurely and you may need to recopy or reprint a file.

What happens after you turn on the energy-saving feature?

When Energy Saver detects that you're not using the computer, it darkens the monitor screen and reduces the amount of energy it consumes. While the monitor is darkened, your computer is still working, but to avoid accidental changes, Energy Saver won't let anything you type or do with the mouse affect any of your work.

To “wake up” the monitor, press any key on the keyboard. Your computer beeps while the monitor is waking up and you can begin work as soon as the computer stops beeping. (The beep volume cannot be adjusted; it is independent of all system sound controls.)

You will save the most energy if your AppleVision 850AV monitor speakers are turned off in energy saver mode. This stops sound output during sleep, but will also prevent you from hearing the complete start up sound when turning on or restarting your computer. If you prefer to hear a system startup sound, you can turn off this option. Click the Preferences button in the Monitor Sound window; then leave the option, “Turn Speakers Off in Energy Saver Mode,” unchecked.

Using Energy Saver with a screen saver

Screen savers are applications you can purchase that put moving patterns on your monitor. Screen saver and Energy Saver applications prevent screen “burn-in.” Energy Saver also conserves energy.

If you wish, you can use Energy Saver and a screen saver program. Set the screen saver to come on before Energy Saver. If your screen saver program includes its own energy-saving feature, you can turn off Energy Saver.



3

Using Sound and Video With Your AppleVision 850AV Display



This chapter describes how to adjust sound on the AppleVision 850AV Display and a Mac OS–based computer. It also describes how to set up your monitor to record a video with sound and play an audio CD through the monitor’s speakers.

If you’re using a Windows-based computer, see Chapter 4, “Using Your Monitor With Windows-Based Computers,” for more information.

Sound controls at a glance

The buttons on the front of your AppleVision 850AV Display provide a quick way to adjust monitor sound.

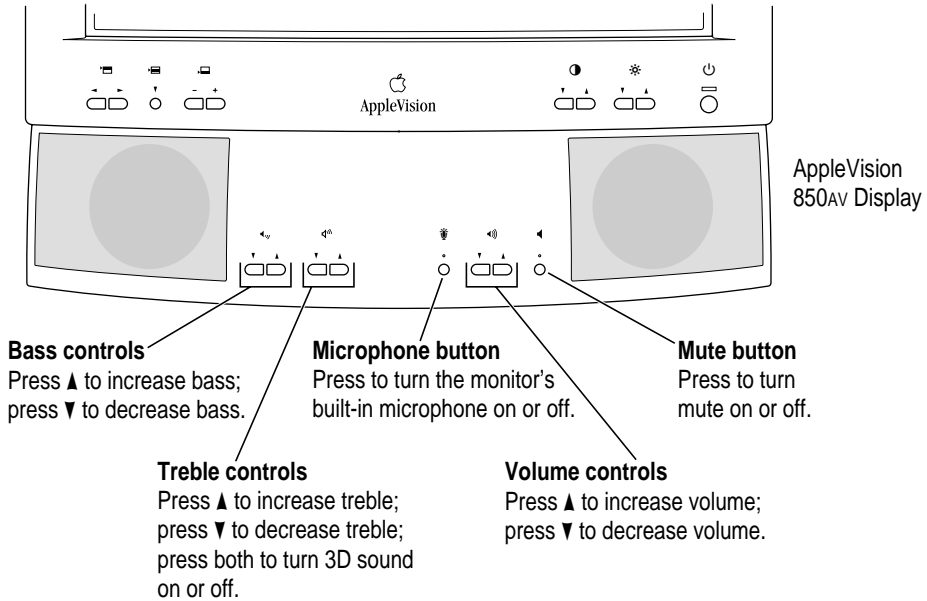

Bass, treble, and volume adjustments have an onscreen indicator that appears when you press a button on the front of the monitor. For example, pressing the Bass button displays the Bass indicator.

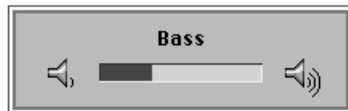

When you make an adjustment, the indicator bar moves to show the current setting. When you've finished making adjustments, the indicator disappears automatically.

About sound sources

Depending on the kind of Mac OS–based computer your AppleVision 850AV Display is connected to, you may have several sound input and output sources:

Sound input sources

- the AppleVision 850AV Display
You can record from the built-in microphone or sound equipment attached to the monitor's sound input port (marked by ) on the left side of the monitor.
- an internal CD-ROM drive
- equipment connected to the back of your computer
This can be an external CD-ROM drive, cassette player, and so on.

Sound output sources



- the AppleVision 850AV Display
You can play sound on the built-in speakers or on sound equipment (such as headphones) attached to the monitor's sound output port (marked by )
- equipment connected to the back of your computer
This can be headphones, speakers, and so on.

To play and record sound, you must first select a sound input source and a sound output device using the Monitors & Sound control panel. See *Monitors & Sound Guide* or the *Monitors & Sound doc.pdf* file for instructions on how to use these and other options available with AppleVision software.

Selecting sound options in Monitors & Sound

Use the Sound button in the Monitors & Sound control panel to configure and adjust sound on your Mac OS–based computer system. Use the Monitor Sound button to configure and adjust sound on your AppleVision 850AV Display.

The following options are available with each button. Some of the options may not be available with your computer/monitor configuration. See *Monitors & Sound Guide* or the *Monitors & Sound doc.pdf* file for detailed information on using the AppleVision software.

Button	Description
	Use the Sound button to choose sound sources for your computer. You can <ul style="list-style-type: none">■ select a sound input port on your computer■ set the desired sound output quality■ set the sound out level
	Use the Monitor Sound button to choose sound sources for your monitor. You can <ul style="list-style-type: none">■ select a sound input source for your monitor■ set the desired gain level for best sound quality while recording or playing sound■ select how the sound from the monitor's input port is routed through your computer system■ set the monitor speaker volume, treble, bass, and sound preferences■ turn 3D sound on and off

Tips for using sound controls

- For most Mac OS–based computers, any sound coming from the computer (from an internal CD-ROM drive, for example) automatically goes to the computer's internal speakers and sound output port. The built-in speakers on your computer are muted automatically when sound equipment (such as the AppleVision monitor) is connected to the sound output port on the back of the computer.
- For best results, adjust the volume on your computer with the Sound controls. Then, use the Monitor Sound controls to adjust the volume on your monitor.
- If you have more than one monitor attached to your computer, the settings in the Monitors & Sound control panel apply only to the monitor listed near the top of the window. The other monitor will have its own Monitors & Sound control panel.

Setting up your monitor to record a video with sound

The following sections describe how to use your AppleVision 850AV Display to record a video with sound. To record a video with sound, you must have a Mac OS–based computer that supports video. For more information about connecting and using video equipment with your computer, see the manuals that came with your computer and video equipment.

About video equipment

If you have a Mac OS–based computer that supports video, you can connect video equipment so that you can display, edit, and store video images on the computer. You can also view or record images on a television or video cassette recorder (VCR).

Your Mac OS–based computer can work with two major video formats:

- S-video, a high-quality video format used by many video cameras and VCRs
- composite video, a video format used by televisions, most VCRs, and laser disc players

To find out which format your equipment uses, check the manual that came with your equipment.

Mac OS–based computers that support video have S-video ports, composite video ports, or both. The video input port brings in images from connected external equipment such as a VCR. The video output port sends images out from the computer to the external equipment.

The following illustration shows S-video and composite video ports on a Mac OS-based computer.

Note: The video ports on your computer may be in a different position.

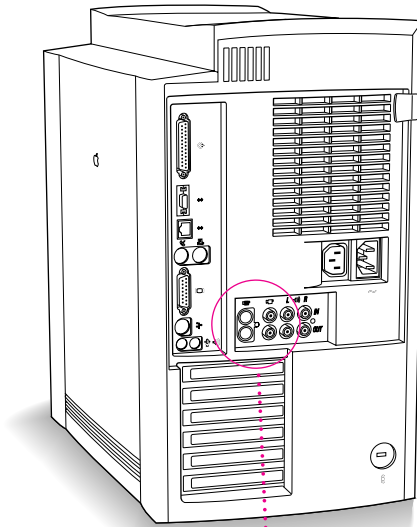

Composite video input port
Connects your Mac OS-based computer to the RCA-type Video Out port of most VCRs, laser disc players, video cameras, and other video input equipment

Composite video output port
Connects your Mac OS-based computer to the RCA-type Video In port of most VCRs, or other video recording or video display equipment

S-video input port
Connects your Mac OS-based computer to the S-video Out port of VCRs, laser disc players, video cameras, or other video input equipment that uses an S-video connector

S-video output port
Connects your Mac OS-based computer to the S-video In port of VCRs, or other video recording or video display equipment that uses an S-video connector

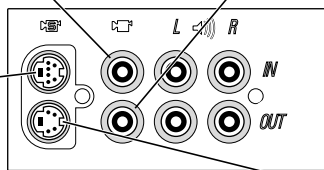

Using video equipment with your monitor

The instructions that follow are for connecting a stereo VCR to a Mac OS–based computer with an S-video port or a composite video port, but you can use them as a model for connecting your computer to any video equipment.

Before you start:

- Make sure that the VCR has a cable with an S-video connector or a composite (RCA plug) connector. If the VCR has an RCA plug, make sure you have an adapter if your computer does not have a composite video port.
- Place the VCR near your computer system.
- Shut down the computer and turn off the VCR.

Note: If your computer has a sound input port and a sound output port in addition to the S-video or composite video ports, you can connect all cables to the back of your computer. See the next section for information.

1 Assemble the cables you need to connect the VCR.

You need the following cables (available at an electronics supply store):

- video cable with S-video connectors or RCA plugs at each end (If you're using a video cable with RCA plugs, you'll also need an adapter cable if your computer does not have a composite video port.)

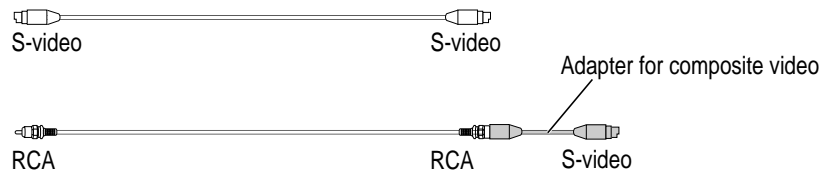

- audio cable with dual RCA plugs at one end and a 3.5-mm stereo miniplug at the other end



- 2 Plug one end of the video cable into the Video Out port on the VCR.**

Follow the instructions that came with the VCR.

- 3 Plug the other end of the video cable into the S-video input port (S^{IN}) or the composite video input port (V^{IN}) on your computer.**

If the connector doesn't slide easily into the port, realign it and try again. Don't use force, which could damage the computer or cable.

- 4 Plug the dual RCA plugs on the audio cable into the left and right Audio Out ports on the VCR.**

- 5 Plug the stereo miniplug on the audio cable into the sound input port (marked by a speaker icon) on the left side of your AppleVision 850Av Display.**

Your finished S-video connections should look like this:

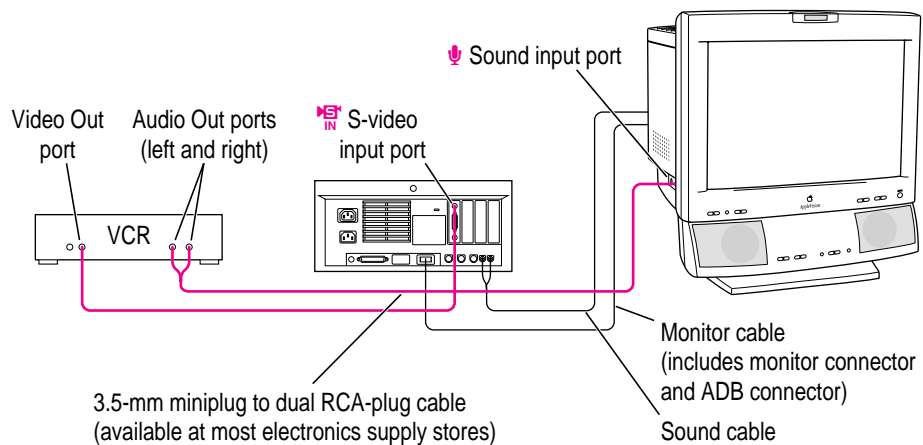

If you use composite video connections, your finished connections will be similar.

- 6 Turn on the computer, the monitor, and the VCR.**

Connecting all audio and video cables to the back of your computer

When you record a video with sound, you can connect all the video equipment to the back of your computer if your computer has S-video or composite video ports as well as sound input and sound output ports for the monitor's sound cable.

To set up your computer for this configuration, follow these steps:

1 Assemble the cables you need to connect the VCR.

You need the following cables (available at an electronics supply store):

- video cable with S-video connectors or RCA plugs at each end (If you're using a video cable with RCA plugs, you'll also need an adapter cable if your computer does not have a composite video port.)

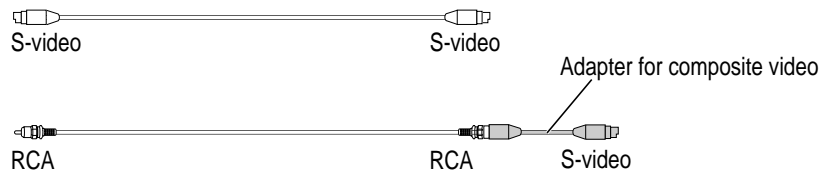

- audio cable with dual RCA plugs at one end and a 3.5-mm stereo miniplug at the other end



- audio cable with dual RCA plugs at each end

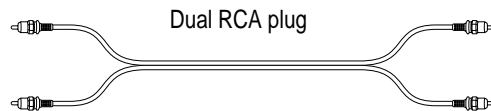

2 Attach one end of the video cable into the Video Out port on the VCR.

Follow the instructions that came with the VCR.

- 3 Plug the other end of the video cable into the S-video input port (S-video icon) or the composite video input port (TV icon) on your computer.

If the connector doesn't slide easily into the port, realign it and try again. Don't use force, which could damage the computer or cable.

- 4 Plug one end of the dual RCA plug cable into the left and right Audio Out ports on the VCR.
- 5 Plug the other end of the dual RCA plug cable into the left and right audio input ports on the back of your computer.
- 6 Plug the stereo miniplug cable into the sound input port (marked by a speaker icon) on the left side of your AppleVision 850AV Display.
- 7 Plug the RCA plug end of the stereo miniplug cable into the audio output ports of your computer.

Your finished S-video connections should look like this:

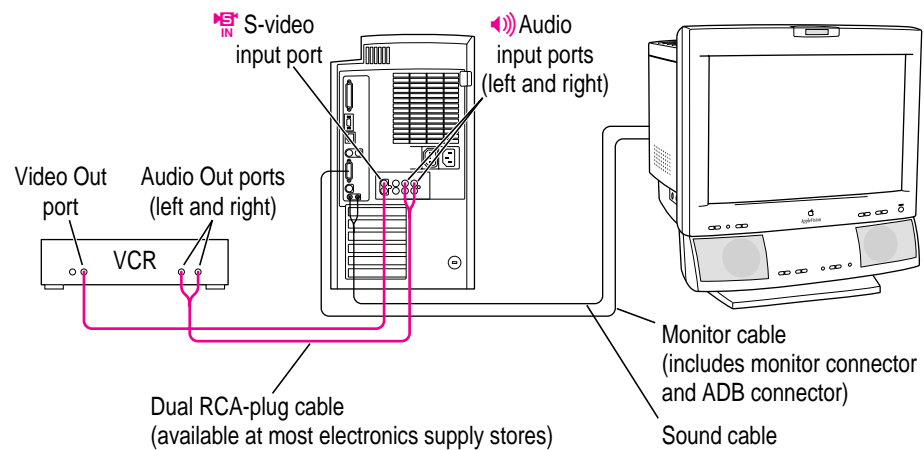

If you use composite video connections, your finished connections will be similar.

- 8 Turn on the computer, the monitor, and the VCR.

Recording a video

After the video equipment is connected to your computer and monitor, you can record a video. See the manual that came with your video application for more information. For example, your application may have additional options for setting sound sources, volume, and so on. Make sure these are set properly.

Playing an audio CD through the monitor's speakers

You can connect an audio CD player to the AppleVision 850AV Display and play the sound through the monitor's speakers.

To play an audio CD, follow these instructions:

- 1 **Turn off the audio CD player and connect it to the sound input port (marked by ) on the left side of the monitor.**

Your monitor and external audio CD player should be connected like this:

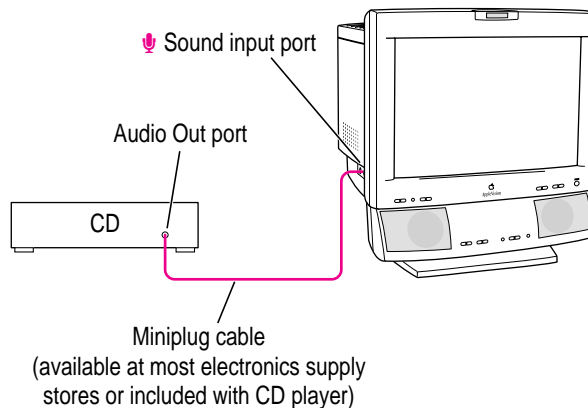

For more information, see “Connecting Sound Equipment to Your AppleVision 850AV Display” in Chapter 1.

- 2 **Click the **Sound** button in the **Monitors & Sound** control panel to open the **Sound** window.**

Make sure you select the appropriate sound input device, such as the microphone or external audio, when you use an external audio CD player.

- 3 **Click the **Monitor Sound** button and adjust the **sound input Port Gain** to “line level.”**

- 4 **Click Routing.**
- 5 **Click Computers and Speakers; then click OK.**
- 6 **Turn on the audio CD player and play a CD.**
- 7 **Adjust speaker volume as desired.**

Use the Speaker Volume slider in the Monitors & Sound control panel or press the volume buttons (marked by ) on the front of your monitor. You should hear the CD sound on your monitor speakers. If not, make sure the audio CD player is connected properly and the audio CD is playing.

Note: You can also use a Mac OS–based computer’s internal CD drive to listen to and record from. Use the AppleCD Audio Player application available in the Apple () menu. The AppleCD Audio Player automatically selects all the appropriate settings.

4

Using Your Monitor With Windows-Based Computers



This chapter describes how to install the AppleVision setup information and adjust the screen image on the AppleVision 850 and 850AV. In most cases, you won't need to adjust the image unless you make changes to screen resolution. This chapter also explains how to control sound on the AppleVision 850AV Display.

For more information about power-saving and environmental features of your AppleVision monitor, see Appendix B.

Note: If you're using the monitor with a Mac OS–based computer, refer to Chapter 2, “Installing and Using AppleVision Software” and Chapter 3, “Using Sound and Video With Your AppleVision 850AV Display.”

Installing AppleVision setup information for Windows 95

On Windows 95 systems, new devices are automatically detected when they are connected to your computer (if it is VESA DDC compliant). If you are not using Windows 95, see the manual that came with your video card for setup information.

To determine that Windows 95 has correctly identified your monitor, check Monitor Type in the Display Properties dialog box. Performing this check will ensure that the AppleVision setup information has been installed. Not installing the AppleVision setup information may limit the resolution and refresh rates on your monitor.

To correctly identify the monitor type in your computer, follow these steps:

- 1 Open the Start menu and choose Settings.**
- 2 Open the Control Panel and double-click the Display icon.**

The Display Properties dialog box appears.

- 3 Click the Settings tab at the top of the dialog box.**

The Settings property sheet appears.

- 4 Click the Change Display Type button in the lower-right corner to display the current Monitor Type.**

If the Monitor Type shown is the AppleVision 850, your computer has correctly identified your monitor. Go to the next section, “Screen Controls at a Glance.”

If the Monitor Type shown is not the AppleVision 850, continue with step 5.

- 5 Press the Change button next to the Monitor Type field; then select AppleVision 850 and click OK.**

If AppleVision 850 is not one of the devices displayed, then the AppleVision setup information file needs to be installed.

6 Insert the *AppleVision Software* CD-ROM disc into your CD-ROM disc drive.

If you do not have a CD-ROM disc drive, see the service and support information that came with your monitor for information on how to order floppy disks.

7 Click the **Have Disk** button.

8 Choose the CD-ROM disc drive and click **OK**.

If an error occurs, make sure you've selected the correct disc drive.

9 Choose the **AppleVision 850** in the **Monitor Type** field and click **OK**.

You're now ready to use the AppleVision monitor with your computer.

Screen controls at a glance

The buttons on the front of your monitor provide a quick way to adjust the screen image. In most cases, you won't need to adjust the screen image unless you make changes to screen resolution.

Use the following buttons to make screen image adjustments:

Control buttons

Use these buttons to make screen image adjustments. See "Using Onscreen Controls" later in this chapter.

Contrast controls

Press ▲ to increase contrast; press ▼ to decrease contrast.

Brightness controls

Press ▲ to increase brightness; press ▼ to decrease brightness.

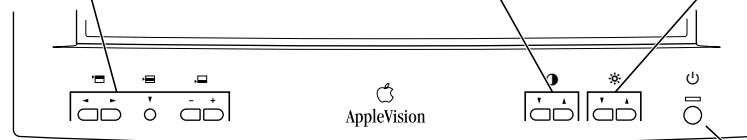

Power button
Press to turn power on or off.

The contrast and brightness adjustments have an onscreen indicator that appears when you press the contrast and brightness control buttons on the front of your monitor. When you make an adjustment, the indicator bar moves to show the current setting. When you've finished making adjustments, the indicator disappears automatically.

Using onscreen controls

Your AppleVision monitor comes with a set of onscreen controls you use to adjust the screen image.

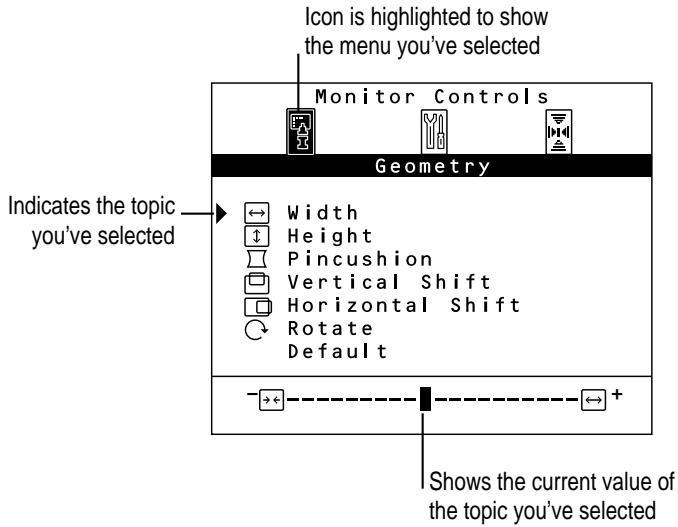

Use the buttons on the front of your monitor to open the Monitor Controls window and select topics from the menus.

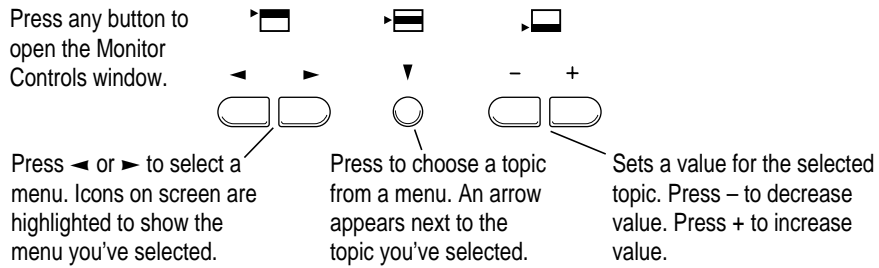

Adjusting screen geometry

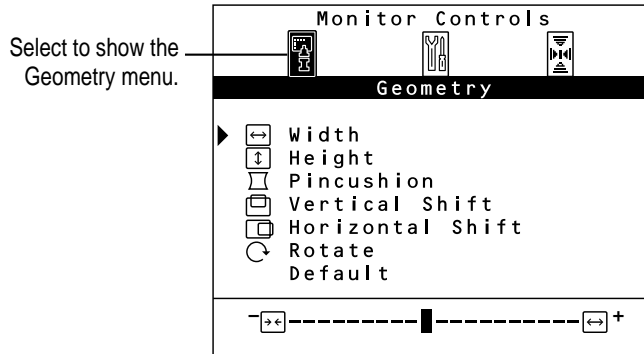

Use the Geometry menu to adjust the height and width of the screen image, center the image on the screen, and so on.

Width

Adjusts the width of the screen image. Press – to decrease width. Press + to increase width. When the width and height of the screen image are set properly, you can see the entire image on the screen.

Height

Adjusts the height of the screen image. Press – to decrease height. Press + to increase height. When the height and width of the screen image are set properly, you can see the entire image on the screen.

Pincushion

Adjusts the shape of the screen image. Press – to bring in the sides of the image, changing the shape from convex to concave. Press + to expand the sides of the image, changing the shape from concave to convex. When the shape of the image is set properly, the left and right sides are straight and the image is rectangular.

Vertical Shift

Adjusts the vertical position of the screen image. Press – to move the image down. Press + to move the image up. When the screen image is centered properly, there is an equal border around all edges of the image.

Horizontal Shift

Adjusts the horizontal position of the screen image. Press – to move the image to the left. Press + to move the image to the right. When the screen image is centered properly, there is an equal border around all edges of the image.

Rotate

Rotates the screen image. Press – to rotate counterclockwise. Press + to rotate clockwise. When the rotation of the screen image is set properly, all four sides of the image are parallel to the edges of the screen and the image is rectangular.

Default

Returns screen adjustments to the preset factory values. Press the + button to turn defaults on.

Adjusting color settings and other features

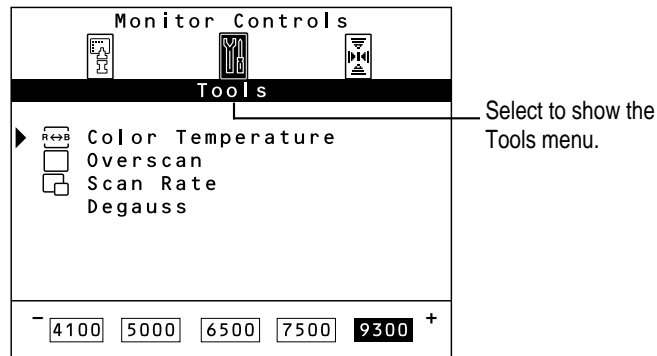

Use the Tools menu to set color temperature, turn overscan on and off, display the scan rate of your monitor, manually degauss, and turn speakers on or off in sleep mode.

Color Temperature

Adjusts the color temperature of your monitor. The color temperature (or *white point*) you select for your monitor sets the mix of red, green, and blue light that makes the color white. This color temperature sets the foundation for other colors on your monitor.

The color temperature of your monitor can be changed to one of the following Kelvin temperatures: 4100 K, 5000 K, 6500 K, 7500 K, or 9300 K. (*Kelvin* is a temperature scale used in scientific applications.)

Press – to decrease color temperature. Press + to increase color temperature. Changing the color temperature changes the appearance of colors on the screen. Lower temperature settings create reddish whites, and higher temperature settings create bluer whites.

Overscan

Turns overscan on and off. Overscan moves the screen image as far to the edges of the screen as possible without distorting the image. Press – to turn overscan off. Press + to turn overscan on.

When overscan is on, you cannot make screen geometry adjustments such as horizontal shift, rotation, and so on.

Scan Rate

Shows the scan rate of the AppleVision 850 and 850AV. This setting is for informational purposes only; it's not for adjusting the scan rate.

Degauss

Manually degausses the monitor. Press + to degauss the monitor.

Audio Power Saver

Turns speakers on or off in sleep mode. Press + to activate Audio Power Saver, which will turn monitor speakers off in sleep mode. Press – to leave monitor speakers on in sleep mode. (This feature is only available on the AppleVision 850AV Display.)

Adjusting convergence

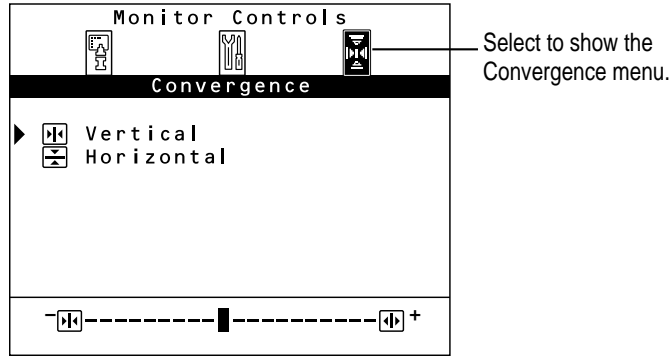

Red, green, and blue signals in your monitor converge to create the colors you see on your screen. If the convergence is not set properly, images or text on your screen may appear blurred, or you may get a “rainbow” effect with several colors forming the edges of images on the screen.

If your monitor is exposed to an external electromagnetic field (for example, from another monitor) over a period of time, you may need to change the convergence to get a clear, distinct screen image.

Use the Convergence menu to adjust screen convergence. When convergence is set properly, the image is clear and distinct.

Vertical

Adjusts the vertical convergence. Press – to move the red signal down and the blue signal up. Press + to move the red signal up and the blue signal down.

Horizontal

Adjusts the horizontal convergence. Press + to move the red signal to the left and the blue signal to the right. Press – to move the red signal to the right and the blue signal to the left.

Adjusting sound on your AppleVision 850AV Display

Use the sound control buttons to adjust the volume, bass, treble, and mute options on your AppleVision 850AV Display. (These features are not available on the AppleVision 850 Display.)

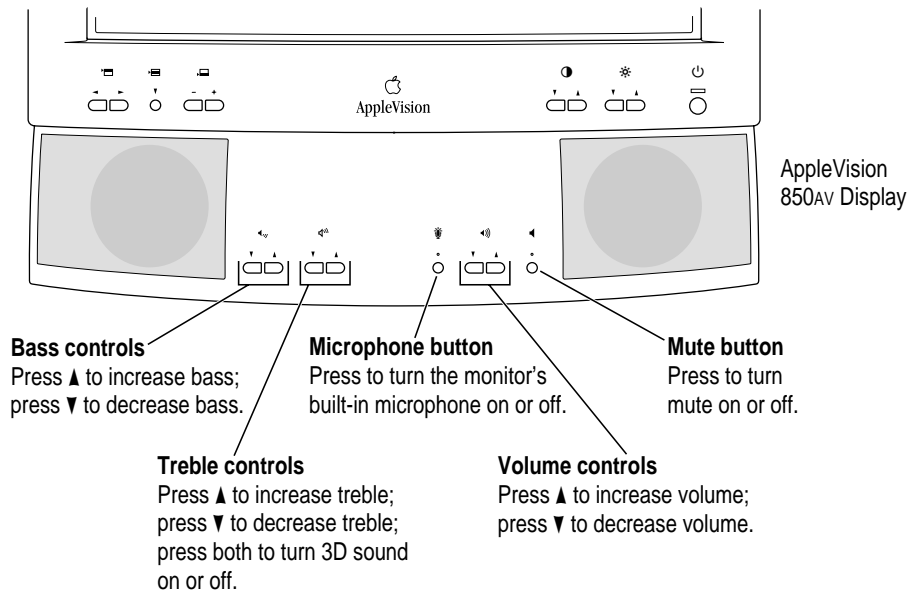

Tips for using sound controls

- For best results, adjust the volume on your computer first. Then, use the sound controls to adjust the volume on your monitor.
- Using the microphone button, turn off the monitor's built-in microphone to activate other equipment (an audio CD player, for example) connected to the sound input port on your AppleVision monitor.

5

Tips and Troubleshooting



This chapter includes information on the care and cleaning of your monitor, protecting your monitor from theft, and troubleshooting.

Care and cleaning

- Do not block the monitor's vents.
- Do not let liquid get on or into the monitor.
- If you will not be using your monitor and computer for a long period of time (a day or more), make sure you turn off the computer (and your monitor, if necessary).

To clean the case and screen of the monitor:

- 1 Turn your computer and monitor off.**
- 2 Disconnect the monitor's power cord.**

If the monitor's power cord is connected to a grounded wall outlet, disconnect the power plug from the outlet.

If the monitor's power cord is connected to the back of your computer, disconnect the monitor's power plug from the back of the monitor.

- 3 Wipe the case surfaces lightly with a clean, soft cloth dampened with water.**

Don't use aerosol sprays, solvents, or abrasives that might damage the finish on the case.

- 4 Use a mild, non-abrasive cleaner on a soft cloth and wipe the screen. Don't spray the cleaner onto the screen, because the liquid may drip inside the monitor.

WARNING Do not use a cleaner that contains alcohol or acetone. You might damage the screen.

Protecting your monitor from theft

The slot at the base of the monitor in the back is for connecting a security lock. It lets you attach a narrow, flexible cable that you can use to secure your monitor (and the rest of your computer system) to prevent theft. Security locks are available from an Apple-authorized dealer or service provider.

Troubleshooting common problems

This section contains descriptions of problems you might experience with your monitor as well as solutions to try. Problems related to the computer itself are covered in the manuals that came with your computer.

WARNING Never remove the cover from the monitor or you may come in contact with hazardous voltage levels capable of causing serious injury and possibly death.

WARNING If you have a problem with your monitor and nothing presented in this manual or in Apple Guide solves it, consult the service and support information that came with your monitor for instructions on how to contact an Apple-authorized service provider or Apple for assistance. If you attempt to repair the monitor yourself, any damage you may cause to the monitor will not be covered by the limited warranty on your monitor. Contact an Apple-authorized dealer or service provider for additional information about this or any other warranty question.

Monitor power and screen appearance

IMPORTANT Detailed instructions for AppleVision software are provided in Macintosh Guide (called Mac OS Guide on some computers) and in Monitors & Sound Guide. System 7.1 users can view AppleVision software instructions in Adobe Acrobat Reader by opening the Monitors & Sound doc.pdf file (located in the AppleVision Extras folder). For Windows users, detailed instructions about onscreen controls are provided in Chapter 4, “Using Your Monitor With Windows-Based Computers.”

The monitor’s power indicator light doesn’t come on.

- Make sure the monitor power button is turned on.
- Make sure the computer is turned on.

The monitor’s power indicator light won’t turn green unless your computer is on.

- Make sure an energy saver program isn’t active on the computer.

The monitor’s indicator light is amber when an energy saver program is on. Also, it may take some time to wake up your computer after you use an energy saver.

- Make sure the power cord is plugged in properly.

If the monitor power cord is plugged into your computer, make sure your computer is on and the cord is firmly plugged in.

If the monitor power cord is plugged into a grounded wall outlet, make sure the cord is firmly plugged in. Check to see whether power to the outlet has been interrupted. You can test the outlet by plugging in something that you know works—like a desk lamp or radio. If the test appliance works, but the monitor doesn’t, contact an Apple-authorized dealer or service provider.

- Make sure the monitor cable is connected to your computer properly.
- Make sure the thumbscrews on the monitor cable are tightened securely.

No image appears on the screen and the monitor's power indicator light is on.

- Make sure the monitor cable is connected correctly to the computer.
- Make sure the thumbscrews on the monitor cable are tightened securely.
- Make sure the contrast (●) and brightness (☼) controls are set correctly. The contrast and brightness controls are on the front of your monitor.
- Restart your computer, holding down ⌘-Option AV. This resets the monitor to factory default settings.

The screen is dark or appears dim.

- Make sure that your computer and monitor are turned on.
- Make sure that the power cord and the monitor cable are securely connected at both ends.
- Increase the contrast and brightness of the screen image. The contrast (●) and brightness (☼) controls are on the front of your monitor.
- A screen saver that darkens your screen may be activated. Press any key on the keyboard to reactivate the monitor.
- On Mac OS–based computers, the Energy Saver option may be activated. Press any key on the keyboard to reactivate the monitor. In approximately 10 seconds, the monitor is reactivated.

Over time, you experience eyestrain.

- Adjust the screen contrast. In a bright room, contrast is usually best set at maximum; in a dim room, lower contrast is usually more comfortable. The contrast (●) controls are on the front of your monitor. Also, be sure to take occasional breaks to focus your eyes on a distant object.
- Adjust the color temperature or white point of the screen image. For most application programs, a white point of 9300 K is best. For Mac OS–based computers, click the Color button in the Monitors & Sound control panel and set a new white point. For Windows-based computers, open the Tools menu, select Color Temperature, and set a new white point.

Contrast (●) and brightness (☼) controls on the front of the monitor don't appear to work.

- For Mac OS–based computers, your monitor may have the contrast (●) and brightness (☼) controls disabled. Click the Color button in the Monitors & Sound control panel and select Preferences. Under Calibration Protection, make sure that the checkbox to disable contrast and brightness controls is not marked; then, click OK.

The screen doesn't dim when Energy Saver or other energy-saving software is on.

- Make sure the energy-saving software is installed properly and the amount of time you've set up to trigger it has passed. For Mac OS–based computers, see “Conserving Energy” in Chapter 2 for more information. For Windows-based computers, see the manual that came with your energy-saving software.

The screen flickers.

- Make sure the monitor cable is connected firmly to the correct port on the back of the computer.
- The flickering could be caused by interference from a nearby power line or electrical equipment—for example, a radio, a microwave oven, or another computer. Try relocating nearby electrical equipment, or moving your computer and monitor.
- If you have more than one monitor attached to your computer, the monitors might be interfering with one another. Make sure you're using a shielded ADB connector cable. Move the monitors farther apart or set the monitors at an angle, so their screens are close and their back panels are farther apart. If, after moving the monitors more than 16 inches apart, you still see flickering, contact an Apple-authorized dealer or service provider.
- If you are using a video card that has a very low refresh rate (below 67 Hz), the monitor may flicker. You may be able to change the refresh rate for the card. If possible, use a 75 Hz setting. See the manual that came with your video card for more information.

There are one or two very thin gray lines across the screen, one near the top and the other near the bottom.

- This is a normal characteristic of the Trinitron color picture tube design. The lines do not appear in any documents you print.

The screen image is off center.

- Adjust the center of the image. For Mac OS–based computers, click the Geometry button in the Monitors & Sound control panel and modify the Position setting. For Windows-based computers, select the Geometry menu; then, click Vertical Shift. Press – to move the screen down and + to move the screen up. Repeat the process for Horizontal Shift.

The screen image is tilted slightly to the left or right.

- Adjust the rotation of the screen image. For Mac OS–based computers, click the Geometry button in the Monitors & Sound control panel and modify the Rotate settings. For Windows-based computers, select the Geometry menu; then, click Rotate. Press – to rotate counterclockwise and + to rotate clockwise.

The screen image is too large or too small.

- Adjust the horizontal or vertical size of the screen image. For Mac OS–based computers, click the Geometry button in the Monitors & Sound control panel and modify the height/width settings. For Windows-based computers, select the Geometry menu; then, click Width. Press – to decrease width and + to increase width. Repeat the process for Height.
- Make sure overscan is off. For Mac OS–based computers, click the Geometry button in the Monitors & Sound control panel and select Off for overscan. For Windows-based computers, select the Tools menu; then, click overscan. Press – to turn off overscan.
- Try changing to another resolution. For Mac OS–based computers, click the Monitor button in the Monitors & Sound control panel and select another resolution. For Windows-based computers, see the manual that came with your computer or video card.

Images or text on your screen appear fuzzy or blurred.

- Adjust the horizontal or vertical convergence of the screen image. For Mac OS–based computers, click the Geometry button in the Monitors & Sound control panel and select Convergence to change settings. For Windows-based computers, select the Convergence menu; then, click Vertical. Press – to move the red signal down and the blue signal up. Press + to move the red signal up and the blue signal down. Then, click Horizontal. Press – to move the red signal to the right and the blue signal to the left. Press + to move the red signal to the left and the blue signal to the right.

The colors on your screen appear too blue, too yellow, or too red.

- Adjust the color settings, recalibrate the monitor, set a new white point, or reset the monitor to the default factory color settings. For Mac OS–based computers, click the Color button in the Monitors & Sound control panel to open color controls. For Windows-based computers, see “Adjusting Color Settings and Other Features” in Chapter 4 for more information.

The screen appears greenish, the screen image is blank or unreadable, or there is “snow” on the screen.

- Make sure the monitor cable is connected firmly to the correct port on the back of the computer.

There are wavy lines on the screen, creating an optical effect or moiré pattern.

- You may see a moiré pattern while in some resolutions, depending on the desktop pattern displayed on the screen (the black-and-white checkerboard pattern frequently causes moiré). For Mac OS–based computers, click the Monitor button in the Monitors & Sound control panel and change to another resolution. For Windows-based computers, see the manuals that came with your computer. To change the desktop pattern, see the manuals that came with your computer or, for Mac OS–based computers, also see Macintosh (or Mac OS) Guide for more information.

Your application program doesn’t recognize changes you make in resolution settings.

- Some application programs do not properly support resolution changes you make to your monitor. You may have to close and restart your program for it to recognize the resolution changes.

Sound on your AppleVision 850Av Display

IMPORTANT Detailed instructions for AppleVision software are provided in Macintosh Guide (called Mac OS Guide on some computers) and Monitors & Sound Guide. System 7.1 users can view AppleVision software instructions in Adobe Acrobat Reader by opening the Monitors & Sound doc.pdf file (located in the AppleVision Extras folder). For Windows users, detailed instructions about sound controls are provided in Chapter 4, “Using Your Monitor With Windows-Based Computers.”

You don’t hear a system beep when you start up your computer.

- Plug your monitor into the wall outlet, not the back of your computer.
- Adjust the volume level on your speakers.
- For Mac OS–based computers, disable the audio energy-saving feature in the Monitors & Sound control panel. Click the Preferences button in the Monitor Sound window; then leave the option, “Turn Speakers Off in Energy Saver Mode,” unchecked.

You don’t hear any sound on your AppleVision 850Av speakers or headphones.

- Increase the volume. Make sure the volume controls in your computer are set correctly first. Then use the audio controls on the front panel of the AppleVision monitor to increase the speaker volume. For Mac OS–based computers, click the Sound button in the Monitors & Sound control panel and adjust the volume on your computer; then click the Monitor Sound button and adjust the monitor speaker or headphone volume. For Windows-based computers, see Chapter 4 and the manuals that came with your computer.
- If you have an audio CD player connected to the sound input port on your monitor, make sure the volume on the audio CD player is set above minimum. For Mac OS–based computers, make sure you’ve selected “line level.” Open the Monitor Sound window of the Monitors & Sound control panel; then, adjust the sound input Port Gain to “line level.”

- If you have sound input equipment connected to your monitor, make sure the correct sound input setting is selected on your computer. For Mac OS–based computers, see Chapter 3, “Using Sound and Video With Your AppleVision 850AV Display,” for more information. For Windows-based computers, see the manuals that came with your computer for more information.
- For Mac OS–based computers, if headphones are connected, but you still want to play sound on your AppleVision 850AV speakers, make sure “Mute speakers when headphones are connected” isn’t checked in the Preferences window. To open Preferences, click the Monitor Sound button in the Monitors & Sound control panel and choose Preferences.
- Check Routing to make sure that the correct configuration is selected. Click the Monitor Sound button in the Monitors & Sound control panel; then, click Routing. Choose Computers and Speakers; then, click OK.
- Make sure the sound cable is plugged into the computer and monitor properly.
- For an internal CD, make sure you’ve selected the correct sound input settings. In the Monitors & Sound control panel, click the Sound button and choose the appropriate sound input device.
- Make sure the headphones are securely connected to the monitor’s sound output port (marked by .



Headphone volume is low.

- Make sure the headphone volume is set to maximum. For Mac OS–based computers, click the Monitor Sound button in the Monitors & Sound control panel and adjust headphone volume. For Windows-based computers, see “Adjusting Sound on Your AppleVision 850AV Display” in Chapter 4 for more information.
- Make sure the volume controls on your computer are set correctly. For Mac OS–based computers, click the Sound button in the Monitors & Sound control panel and adjust computer speaker volume. For Windows-based computers, see the manuals that came with your computer for more information.

The internal microphone doesn't record.

- Turn on the microphone by pressing the microphone button (marked by ) on the front of your monitor. When the microphone is on, the microphone indicator light is on.
- For Mac OS–based computers, after you have pressed the microphone button on the monitor, make sure you've selected the internal microphone as the sound input source in the Sound window of the Monitors & Sound control panel.
- Make sure the monitor's sound cable is connected properly. See “Connecting Sound Equipment to Your AppleVision 850AV Display” in Chapter 1.

The microphone button on your keyboard doesn't turn on your monitor microphone.

- Some adjustable keyboards for Mac OS–based computers have a button marked by . This button does not turn on the built-in microphone on your AppleVision 850AV Display. Instead, use the microphone button (marked by ) on the front of the monitor.

You can still hear internal computer speakers when playing sound on the AppleVision 850AV speakers.

- On some computers, you must manually mute the internal computer speakers. Click the Sound button in the Monitors & Sound control panel; then make sure that mute is selected in the Computer System Volume dialog box. See Macintosh (or Mac OS) Guide or the manuals that came with your computer for more information.

AppleVision 850AV speakers don't mute when headphones are connected.

- Make sure “Mute speakers when headphones are connected” is selected in the Preferences dialog box. Click the Monitor Sound button in the Monitors & Sound control panel; then, click Preferences.

Playback doesn't work on your AppleVision monitor.

- Some third party sound cards do not support simultaneous input and output, meaning playback won't work if the AppleVision monitor is plugged into both ports. If this happens, unplug one port in order to make the other port work. See the information that came with your sound card or computer for more information.

An external microphone connected to the sound input port (marked by  on the monitor doesn't record quality sound.

- For Mac OS–based computers, you may need to adjust the Gain for the microphone. Click the Monitor Sound button and adjust the Gain for the microphone.
- Some external microphones don't work well with the AppleVision 850AV Display. Use the monitor's built-in microphone, or plug the external microphone directly into the sound input port on the back of your computer.
- If you're using the AppleVision 850AV Display with another monitor that records sound, turn off the microphone on the other monitor. With both microphones on, you may get feedback or other interference.

Selecting Mute in an application program's window doesn't mute sound coming from the monitor.

- For Mac OS–based computers, some programs cannot mute sound coming from the AppleVision 850AV Display. To mute the sound, select Mute Monitor Sound in the Monitor Sound window of the Monitors & Sound control panel.

Your third party driver no longer shows up in your Monitors & Sound control panel.

- Some Mac OS–based sound drivers require the Sound control panel, an older control panel that has been replaced on your computer by the Monitors & Sound control panel. You can reinstall the Sound control panel. Open the Apple Extras folder on your hard disk and double-click the AppleVision Extras folder. Double-click the Sound control panel icon.

Monitors & Sound control panel for Mac OS–based computers

IMPORTANT Detailed instructions for AppleVision software are provided in Macintosh Guide (called Mac OS Guide on some computers) and Monitors & Sound Guide. System 7.1 users can view AppleVision software instructions in Adobe Acrobat Reader by opening the Monitors & Sound doc.pdf file (located in the AppleVision Extras folder).

The name of your monitor doesn't appear in the Monitors & Sound control panel.

- After you set up your AppleVision monitor, make sure the monitor power is on and restart your computer.
- Make sure the ADB connector on the monitor cable is plugged directly into your computer's ADB port.
- Make sure you've installed the AppleVision software that came with your monitor. See "Installing AppleVision Software" in Chapter 2 for more information.
- You may be using a video card that's not compatible with your monitor. Contact the manufacturer of the video card for information.

A message appears, "This version of system software is not supported by the AppleVision software."

- Make sure you're using System 7.1 or later.
- If this message appears in the AppleVision software installer, make sure you select the startup hard disk in the Installation dialog box.

A message appears, "The AppleVision preferences are invalid and may have become corrupted."

- Delete the AppleVision Preferences folder on your hard disk and restart your computer.

A message appears, "An error has occurred reading from or writing to a file."

- Make sure you are not starting up from a non-writable disk, such as a CD, a locked hard drive, or a floppy disk.

A message appears, “This monitor is not supported by this version of the AppleVision software.”

- Make sure you have installed the AppleVision software that came with your monitor. See Chapter 2, “Installing and Using AppleVision Software,” for more information.

A message appears, “AppleVision failed to load,” followed by an error code.

- Make sure you’ve plugged the monitor connector and ADB connector on the monitor cable into the correct ports. You may have plugged them into the wrong ports by mistake. See “Connecting the Monitor Cable to a Mac OS–based Computer” in Chapter 1 for more information.
- Make sure your video card supports the AppleVision monitor. See the manual that came with your video card or computer.
- Some viruses can cause problems with the AppleVision software. Make sure you regularly scan your computer for viruses.
- If AppleVision software is installed and you start up your computer holding down the Shift key, the Display Enabler extension will not load and the software will not run. Restart your computer without disabling extensions to use the AppleVision software.
- If none of the suggestions solves the problem, reinstall the AppleVision software.

The Monitors & Sound control panel opens, but does not include the Geometry, Color, or Monitor Sound buttons.

- Make sure the ADB connector on the monitor cable is plugged directly into your computer’s ADB port.
- Reinstall the AppleVision software that came with your computer. See Chapter 2, “Installing and Using AppleVision Software,” for more information.

ColorSync Profile files are not updated when ColorSync is installed.

- Out-of-date profiles in the ColorSync Profiles folder are not removed automatically. If you want to remove a ColorSync profile, you must do so manually. See Appendix A, “Using ColorSync,” for more information about ColorSync.

Your AppleVision monitor appears as a VGA monitor in the Control Strip pop-up menus.

- Make sure the ADB connector on the monitor cable is plugged directly into your computer's ADB port.
- Reinstall the AppleVision software that came with your computer. See Chapter 2, "Installing and Using AppleVision Software," for more information.

You hear no alert sound.

- Make sure the alert volume control is set correctly. Click the Alerts button in the Monitors & Sound control panel and reset the System Alert Volume.

Changes in the Monitors & Sound control panel don't work for the monitor.

- Make sure you have installed the AppleVision software that came with your monitor.
- Because each monitor connected to your computer has its own Monitors & Sound window, use the window that displays the name of your AppleVision monitor in the top-left corner.

When you open the Monitors & Sound control panel, only one resolution is available.

- Make sure you have connected the ADB connector to your computer. You cannot use many of the features of the AppleVision software without an ADB connection. See "Connecting the Monitor Cable to a Mac OS-Based Computer" in Chapter 1 for more information.
- If AppleVision software is installed and you start up your computer holding down the Shift key, the Display Enabler extension will not load and the software will not run. Restart your computer without disabling extensions to use the AppleVision software.
- Reinstall the AppleVision software that came with your computer. See Chapter 2, "Installing and Using AppleVision Software," for more information.

When you turn on overscan, it stays on even when you change resolutions.

- This is a new feature of the AppleVision 850 and 850AV. In other AppleVision monitors, overscan will automatically turn off when you change resolution settings.

No colors appear on the screen.

- Check to make sure that the number of colors is set correctly in the Control Strip or in the Monitors & Sound control panel.

No colors appear when you create a custom white point.

- Make sure the color depth on your monitor is set to Thousands of Colors or Millions of Colors. Click the Monitor button in the Monitors & Sound control panel and reset the color depth, or use the Control Strip to change settings.

You do not have a CD-ROM disc drive for installing the AppleVision software.

- You can order a set of floppy disks of the AppleVision software. See the service and support information that came with your monitor for more information. Support information and Apple software updates are also available via Apple's World Wide Web sites: <http://www.info.apple.com> and <http://www.support.apple.com>.



Appendix A Using ColorSync

•••••

Mac OS–based computers use ColorSync to help make sure that the colors you see on your monitor closely match the colors you get on your printers, scanners, and other devices. Because ColorSync works behind the scenes, you don't have to know anything about it. All you need to do is initially set it up. This appendix describes how ColorSync works and how to configure your monitor and computer to take advantage of it.

The problem that ColorSync solves

Providing consistent color with desktop computers is a technical challenge because different color devices use different methods for representing color, and they produce different ranges of colors. For example, the colored light on your monitor is very different from the colored inks your printer uses.

Different color devices also create color using different methods. Monitors (and most scanners) produce colors by mixing red, green, and blue light—called *RGB color*. Most printers produce colors by mixing cyan (a shade of blue), magenta (a bright pink), yellow, and black ink. This color system is called *CMYK*. Since monitors, printers, and scanners each have different color capabilities, they cannot reproduce each other's colors exactly.

Further compounding the problem is that no two monitors or printers produce exactly the same colors. (For example, you can see differences in color ability among monitors in the TV department of a consumer electronics store.)

ColorSync is a system extension that provides color-conversion capabilities and improves color consistency. ColorSync “translates” the colors used on one device so that they more closely match the colors displayed or printed on another device.

ColorSync color conversion is a central part of Mac OS–based computing, ensuring that applications, monitors, printers, scanners, and digital cameras can use the same scheme for color conversion. This means you can scan an image, display it on your monitor, and print it—with visually matching colors every step of the way.

How ColorSync works

When you create a TIFF or PICT file using a program that supports ColorSync, a “profile” describing the color capabilities of your equipment is saved with the image. For example, when you scan a photograph, a profile describing the scanner is saved inside the image file. If you later print the image, even using a different computer, ColorSync looks at the profile to learn about the capabilities of the scanner you used, and automatically picks closely matching colors that your printer can reproduce.

The profile contains information ColorSync needs to perform color matching, such as the lightest and darkest possible tones (white point and black point) that the device can produce, and the maximum supported densities for red, green, blue, cyan, magenta, and yellow. Together, these characteristics describe the *color gamut* (or *range*) that a device is capable of capturing, displaying, or reproducing. To take advantage of ColorSync, each of the imaging devices you use needs to have its own ColorSync profile. When you create images using these devices, information from the profile will automatically become part of the image file—ensuring that colors are consistent throughout the entire creative process.



Because ColorSync information becomes part of your output files, you don't have to worry about losing the profile or using the wrong profile with the wrong image. Additionally, ColorSync profiles are in the standard International Color Consortium (ICC) format recognized by Microsoft Windows, Mac OS, and other systems.

When you work with an image that has an embedded ColorSync or ICC profile, ColorSync identifies the colors that your monitor or printer can reproduce by examining their ColorSync profile. It compares their capabilities with those of the system used to create the image (as described in the embedded profile), and then picks appropriate, matching colors. For example, your monitor may be able to display a vivid red, but your printer inks may not be able to produce that color. ColorSync determines the “next best” color for your printer to use.

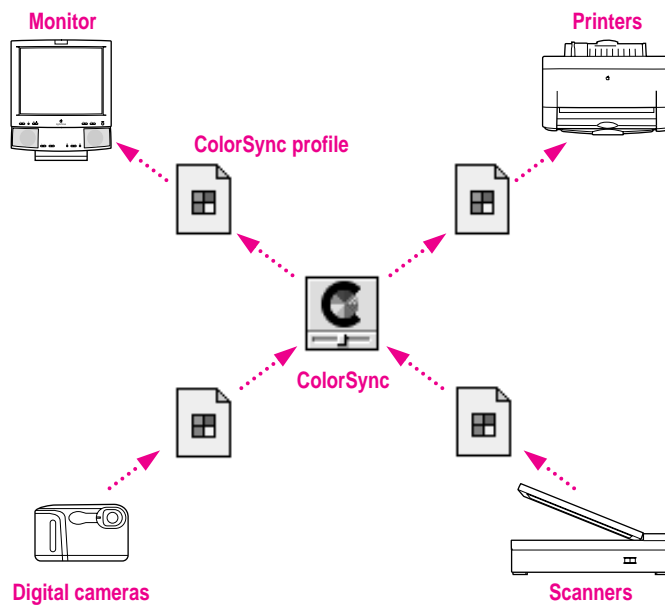

ColorSync performs color matching by comparing each profile to an independent color standard. ColorSync uses the CIE color standard, which describes colors in terms of how they are perceived by the human eye under specific lighting conditions. (CIE stands for the Commission International de l’Eclairage, the International Commission on Illumination, which created the standard in 1931.)

Setting up ColorSync

To take advantage of ColorSync, you need to obtain profiles for each of your imaging devices, such as your monitor, scanner, and color printer. ColorSync profiles are usually automatically installed when you install the software for a ColorSync-supported device. Profiles are stored in the ColorSync Profiles folder, inside Preferences in the System Folder. If you need to obtain a ColorSync profile, contact the manufacturer of your device. Ask for either a ColorSync or ICC profile for the specific model of monitor, printer, or scanner you're using.

You also need to make sure the ColorSync extension is installed and active. ColorSync is automatically installed in the Extensions folder of your System Folder during AppleVision software installation. Unless you've removed or disabled it, it's already installed.

Finally, you need to set a ColorSync System Profile for the Mac OS. The ColorSync System Profile is used by ColorSync to determine the color range of your monitor. ColorSync compares this information with the profiles of your other devices to make sure that colors are consistent with what you see on your monitor.

Additionally, the System Profile is used as a default profile if a document you are working on doesn't have any ColorSync information saved within it. This can occur if the document was created without ColorSync installed. By using the System Profile as a default, ColorSync ensures that colors are consistent with what you currently see on your monitor.



Setting the ColorSync System Profile

To set the System Profile, follow these steps:

- 1 **Make sure the profile you want to use is located in the ColorSync Profiles folder.**

This folder is located in the Preferences folder in your System Folder.

- 2 **Choose Control Panels from the Apple () menu and open the ColorSync System Profile control panel.**

The ColorSync System Profile control panel appears.

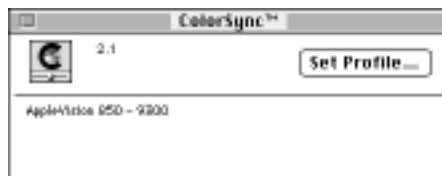

- 3 **Click Set Profile.**

A dialog box appears with a list of ColorSync profiles installed on your computer.

- 4 **Click the profile you want to use or create your own custom profile.**

Note: The profile names may appear different on your screen.



Select the profile for the AppleVision 850 monitor. If you've created a custom ColorSync profile that describes your color settings, select it as the system profile instead. See *Monitors & Sound Guide* or the *Monitors & Sound doc.pdf* file for more information on creating custom ColorSync profiles.

5 Click Select.

ColorSync automatically references the profile you selected and uses it to define the color capabilities of your monitor.

6 Close the ColorSync System Profile control panel.

Setting other ColorSync profiles

Some programs and printer software might require that you do something special, such as turning on an option, in order to take advantage of ColorSync. For example, to use ColorSync with the Apple Color OneScanner, select the Use ColorSync option in the ColorSync Preferences dialog box of the OneScanner Dispatcher software. This tells the scanning software to embed information about the Color OneScanner in scanned images.

Refer to the instructions that came with your application or device to determine if it supports similar options. If there's an option to specify a profile or to activate ColorSync, be sure to use it.

Tips for best results

After you've made sure ColorSync is installed, set the System Profile, and set any necessary ColorSync options for your applications, you're ready to begin taking advantage of ColorSync! Just scan, create, and print your images or documents as you normally would. ColorSync works behind the scenes to ensure consistent color matching.

The following settings and strategies will help you get the best color results from your system. Not all of these tips will apply to the software and devices you may be using, but be sure to take advantage of those tips that do.

- Set the gamma curve for your monitor to 1.8:Standard to have the monitor more closely match printed results. See *Monitors & Sound Guide* or the *Monitors & Sound doc.pdf* file for more information on gamma settings available in the *Monitors & Sound* control panel.

- Use the ColorSync System Profile control panel in the Apple (🍏) menu to select the AppleVision 9300 profile if your white point is set to 9300 + 8MPCD. If you calibrate your monitor to a white point setting other than 9300 + 8MPCD, create a custom profile and select it as the system profile instead. See *Monitors & Sound Guide* or the *Monitors & Sound doc.pdf* file for more information on creating custom ColorSync profiles.
- Share custom ColorSync profiles describing your AppleVision color settings with others to help ensure color accuracy for images you create using your AppleVision monitor. See *Monitors & Sound Guide* or the *Monitors & Sound doc.pdf* file for information on exporting ColorSync profiles.
- When printing in color, check to see if the printing options include a setting for ColorSync. For example, for the Apple LaserWriter 12/600 PS, turn on ColorSync by clicking the Options button and selecting “ColorSync Color Matching.”
- If your scanning program has a ColorSync option, use it. This embeds a ColorSync profile within the scanned image file, and ColorSync will be better able to reproduce the original colors on your monitor and printer.
- Don’t try to use two color-matching systems at once on your computer. Some applications install other color-matching systems. These should either be removed or disabled if you want to use ColorSync.



Appendix B Technical Information

• • • • •

Picture tube

- 20-inch (19.0-inch diagonal viewable image size) Trinitron CRT

Screen

- Multilayer anti-reflection panel conforms to TCO 92 guidelines
- 0.26 millimeter (mm) stripe pitch
- 0.25 mm grille pitch

Input signals

- Red, green, and blue video signals
- Multiple scan
- DDC clock and data signals
- Vertical Refresh Rate: 48 hertz (Hz) to 120 Hz
- Horizontal Scan Rate: 30 Kilohertz (kHz) to 94 kHz

Power-saving and environmental features

AppleVision monitors are equipped with energy-saving features that allow the monitors to conserve energy when the computer is not in use. The color of the power indicator light on the front of the monitor indicates the operating mode:

Mode	Power consumption: watts (W)	Power indicator
Normal	<150 W (850) <180 W (850AV)	Green
Monitor sleep	<30 W (850 and 850AV)	Orange
System sleep	<5 W (850) <5 W (850AV with speakers off) <30 W (850AV with speakers on)	Orange

For instructions on adjusting the system and monitor sleep settings, and additional energy-conservation information, see “Conserving Energy” in Chapter 2. System 7.5 (or later) users should also see Macintosh Guide (also called Mac OS Guide).

- TCO 92 compliant

This product has been certified by TCO (the Swedish confederation of Professional Employees) to meet global standard safety tests and have energy-saving features such as automatic monitor power down and reduced electromagnetic fields.

- MPR II compliant to ensure reduced electromagnetic and electrostatic emissions

- Energy Star compliant

This product complies with the United States Environmental Protection Agency’s Energy Star criteria for energy-efficient office products. The EPA Energy Star Office Equipment program is a partnership program to promote energy-efficient personal computers, monitors, printers, fax machines, and copiers. Reducing the energy consumption from this equipment can help combat smog, acid rain, and climate change by decreasing emissions from electricity generation.

- DPMS compliant

This product's power-saving features comply with the Video Electronics Standards Association (VESA) Display Power Management Standard (DPMS). (Connected CPU must also be VESA DPMS compliant to use DPMS features.)

User controls

- Power-on button
- Automatic degauss at startup; manual degauss by turning power switch off, then on
- Control buttons: contrast, brightness, and five buttons for onscreen controls
- Audio control buttons for AppleVision 850AV Display: bass, treble, microphone on, volume, and mute
- Additional picture and sound controls available using the Monitors & Sound control panel (Mac OS–based computers) or onscreen controls (Windows-based computers)

Factory preset timings

- Adjusted at the factory for the following standard modes:

Mode	Resolution	Vertical refresh rate (hertz)	Horizontal scan rate (kilohertz)
VGA	640 x 480	60	31.469
Macintosh	640 x 480	67	35.036
VESA	640 x 480	72	37.861
VESA	640 x 480	75	37.500
VESA	640 x 480	85	43.269
VESA	800 x 600	56	35.160
VESA	800 x 600	60	37.879
VESA	800 x 600	72	48.077
VESA	800 x 600	75	46.875
VESA	800 x 600	85	53.674
Macintosh	832 x 624	75	49.700
IBM	1024 x 768	87 Int	35.522 interlaced

continued ►



Mode	Resolution	Vertical refresh rate (hertz)	Horizontal scan rate (kilohertz)
VESA	1024 x 768	60	48.363
VESA	1024 x 768	70	56.476
VESA	1024 x 768	75	60.023
VESA	1024 x 768	85	68.677
Macintosh	1152 x 870	75	68.700
VESA	1280 x 1024	75	79.976
VESA	1280 x 1024	85	91.146
VESA	1600 x 1200	75	93.750

Audio input signals for AppleVision 850Av Display

- Accepts audio signal of up to 4 Vpp (line level–low sensitivity) or as low as 4.4 mVpp (microphone level–high sensitivity) without clipping the signal, depending upon the level and sensitivity setting

Microphone for AppleVision 850Av Display

- Directional, optimized for use in speech recognition and other voice-related application programs

Speakers for AppleVision 850Av Display

- Stereo, with ported (bass reflex) chamber design
- Speaker SPL output: > 90 decibel (dB) SPL at 1 kHz at 0.5 meters
- Frequency response: 80 Hz to 17 kHz \pm 6 dB

Spatial enhancements and 3D sound features of AppleVision 850Av speakers

- Single channel driven by 2 Vpp, 1 kHz input at external jack
- Output voltage at other channel > 0.38 VRMS (measured at output of spatial effect enhancement IC).

Headphone jack for AppleVision 850Av Display

- Maximum output level (2 Vpp line level input):

Into 600 ohm (Ω) load	> 0.50 volts (v) RMS
Into 10 Kilohm ($k\Omega$) load	> 0.55 v RMS

Input electrical requirements

- Voltage: 90-264 V
- Frequency: 47-63 Hz
- Power:
 - Apple Vision 850 150 W maximum
 - Apple Vision 850AV 190 W maximum

Weight

- Apple Vision 850 Display: Approximately 67 pounds (30 kilograms)
- Apple Vision 850AV Display: Approximately 77 pounds (35 kilograms)

Dimensions of Apple Vision 850 Display

- Height 474 millimeters (mm) \pm 3 mm
- Width 484 mm \pm 3 mm
- Depth 515 mm \pm 3 mm
(not including cables)

Dimensions of Apple Vision 850AV Display

- Height 553 millimeters (mm) \pm 3 mm
- Width 484 mm \pm 3 mm
- Depth 545 mm \pm 3 mm
(not including cables)

Interfaces for Apple Vision 850 Display

- Apple Desktop Bus (ADB): Two ADB pass-through output ports

Interfaces for Apple Vision 850AV Display

- Apple Desktop Bus (ADB): Two ADB pass-through output ports
- Microphone: One input port and one built-in microphone
- Headphone/Speaker: Built-in speakers

Color compatibility

- Works with ColorSync 2.1 or later. ColorSync profiles are compatible with the profile specifications of the International Color Consortium (ICC).

Temperature

Celsius (C) and Fahrenheit (F)

- Operating 10° to 40° C (50° to 104° F)
- Storage 0° to 60° C (32° to 140° F)
- Shipping –40° to 60° C (–4° to 140° F)

Humidity (noncondensing)

- Operating 20% to 95%
- Storage 5% to 95%
- Shipping 5% to 95%

Altitude

- Operating 0 to 10,000 feet (ft.)
0 to 3048 meters (m)
- Shipping 0 to 35,000 ft.
0 to 10,670 m



Display cable specifications

- 15-pin miniature D-type connector

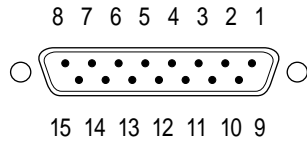

Pin	Signal
1	Red video ground
2	Red video
3	Not used
4	ID 1/DDC RTN
5	Green video
6	Green video ground
7	ID 2/DDC SCL
8	DDC 5V
9	Blue video
10	ID 3/DDC SDA
11	Vertical Sync return
12	Vertical Sync
13	Blue video ground
14	Horizontal Sync return
15	Horizontal Sync
Shell	Shield ground

VGA adapter specifications

- Standard 15-pin VGA connector

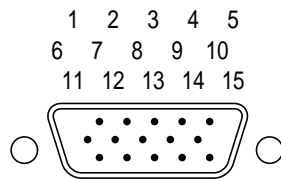

Pin	Signal
1	Red video
2	Green video
3	Blue video
4	Monitor ID 2
5	DDC return
6	Red return
7	Green return
8	Blue return
9	DDC 5V
10	Sync return
11	Monitor ID 0
12	SDA (ID 1)
13	Horizontal Sync
14	Vertical Sync
15	SCL (ID 3)
Shell	Shield ground



Can't Find It? See also Macintosh Guide's onscreen index. Open the Guide (Ⓜ) menu and choose Macintosh Guide (or Mac OS Guide); then click the Index button.

Index



A

adapters

- for connecting to a composite video port 47, 48, 50

- for connecting to a high-density port 14

- VGA adapter 14, 15, 95

ADB cables 13, 16

ADB connector 5, 7, 13, 16

ADB port

- connecting the keyboard to 16
- connecting the monitor to 12–13
- connecting the mouse to 16
- connecting two monitors to 20
- location of 5, 7

adjusting monitor sound

- Mac OS–based computers 34, 42–44
- Windows-based computers 63

adjusting screen images

- Mac OS–based computers 32–38
- Windows-based computers 58–62

adjusting the screen 10–11

Adobe Acrobat Reader 30–31

Alerts button (Monitors & Sound control panel, Mac OS) 34

alert sound (Mac OS)

- changing 34
- troubleshooting 78

altitude requirements 93

amber power indicator light 21

ambient light setting, changing (Mac OS) 34

angle of the monitor, adjusting 10

Apple-authorized service provider 66

AppleCD Audio Player application (Mac OS) 53

Apple PlainTalk Microphone 18

AppleVision 850AV Display

- adjusting sound on (Mac OS–based computers) 34, 42–44

- adjusting sound on (Windows-based computers) 63

- connecting sound equipment to 17–19

- connecting to your computer 11–17

- connecting video equipment to (Mac OS–based computers) 48–51

- controlling built-in speakers on (Mac OS–based computers) 34, 42–44

- controlling built-in speakers on (Windows-based computers) 63

- dimensions of 92

- illustration of 4, 5

- recording videos with (Mac OS–based computers) 45–52

- sound controls on front of 42, 63

- specifications for 89–95



Can't Find It?

See also **Macintosh Guide's onscreen index**.
Open the Guide (🔍) menu and choose **Macintosh Guide** (or **Mac OS Guide**); then click the **Index** button.

turning speakers on or off in sleep mode (Mac OS–based computers) 40
turning speakers on or off in sleep mode (Windows-based computers) 60, 61
weight of 9, 92

AppleVision 850 Display
connecting to your computer 11–17
dimensions of 92
illustration of 6, 7
specifications for 89–95
weight of 9, 92

AppleVision setup information for Windows 95 operating system 56–57

AppleVision Software CD-ROM disc 25, 30, 57

AppleVision software (Mac OS) 25–40
Control Strip in 36
DigitalColor Meter in 36–37
Energy Saver control panel in 38–40
floppy disk version of 79
installing 25–28
Monitors & Sounds control panel in 33–35, 43–44
onscreen help for 28–30
Pantone Color Picker extension in 38
software license agreement for 26
tips for using 35
using with System 7.1 operating system 30–31
using with System 7.5 operating system or later 28–30

Apple World Wide Web sites 23

Arrange button (Monitors & Sound control panel, Mac OS) 34

audio cable 48, 50

audio CDs, playing (Mac OS–based computers) 52–53. *See also* CD player

audio control buttons 90

audio input signals 91

Audio Power Saver option (Tools menu, Windows) 61

B

bass, setting
Mac OS–based computers 42, 44
Windows-based computers 63

bass controls 5, 42, 63

blank or unreadable screen 71

blurred images or text 71

brightness
adjusting (Mac OS) 32, 34
adjusting (Windows OS) 57
troubleshooting (Mac OS) 69

brightness controls 5, 7, 32, 57

built-in microphone (AppleVision 850AV Display)
illustration of 5
as sound input source (Mac OS) 43
specifications for 91
troubleshooting 74
turning on and off (Mac OS–based computers) 42
turning on and off (Windows-based computers) 63

built-in speakers (AppleVision 850AV Display)
adjusting sound (Mac OS–based computers) 34, 42–44
adjusting sound (Windows-based computers) 63
energy saver mode and (Mac OS) 40
illustration of 4, 5
muting (Mac OS–based computers) 42, 74, 75
muting (Windows-based computers) 63
playing audio CDs through (Mac OS–based computers) 52–53
as sound output source (Mac OS–based computers) 43
specifications for 91
troubleshooting 72, 73, 74
turning on or off in sleep mode (Mac OS) 40
turning on or off in sleep mode (Windows) 60, 61

buttons on front of the monitor 32, 42, 57, 63

C

cables

- ADB cables 13, 16
- audio cable 48, 50
- keyboard cable 16
- monitor cable 5, 7, 12–15
- mouse cable 16
- shielded connector cable 20
- sound cable 5, 17
- video cable 48, 50

case, cleaning 65

cassette player 19, 43

CD player. *See also* audio CDs

choosing (Mac OS) 34

connecting 19

playing sound through the monitor's speakers (Mac OS–based computers) 52–53

playing sound through the monitor's speakers (Windows-based computers) 63

as sound input source (Mac OS–based computers) 43

CD-ROM drive, internal (Mac OS–based computers) 43, 53

cleaning

case 65

screen 1, 65–66

color

compatibility of 92

consistency of. *See* ColorSync

depth of, changing (Mac OS)
34, 35, 36

specifying with Pantone Matching System (Mac OS) 36

troubleshooting 71, 79

white point, setting (Mac OS) 34

white point, setting (Windows) 61

Color button (Monitors & Sound control panel, Mac OS) 34, 35

color calibration, setting (Mac OS) 34

color conversion 82. *See also* ColorSync

color settings, adjusting (Mac OS)

34, 35, 36–38

color settings, adjusting (Windows)
60–61

ColorSync (Mac OS) 81–87

how it works 82–83

importing/exporting ColorSync profiles 34

problem solved by 81–82

setting the ColorSync System Profile
85–86

setting up 84–86

tips for best results with 86–87

ColorSync System Profile control panel 85

color temperature, setting

Mac OS–based computers 34

Windows-based computers 61

Color Temperature option (Tools menu, Windows) 61

Communications regulation information
viii

composite video format 45, 46, 47, 48

composite video ports 45, 46, 47, 48

computers. *See* Mac OS–based computers; Windows-based computers

connecting sound equipment to your AppleVision 850AV Display
17–19

connecting the monitor to your computer
11–17

connecting a Mac OS–based computer keyboard and mouse to your monitor 16

connecting the monitor cable to a Mac–OS based computer 12–14

connecting the monitor cable to a

Windows-based computer 15

connecting the monitor cable to video connectors 14

connecting the power cord 12

connecting to a standard monitor port
12–13

safety precautions for 11, 13, 47

using more than one monitor 20



Can't Find It?
See also Macintosh
Guide's onscreen index.
Open the Guide (🔍)
menu and choose
Macintosh Guide
(or Mac OS Guide);
then click the
Index button.

connectors
 ADB connector 5, 7, 13, 16
 extended miniplug 18
 monitor connector 5, 7, 12–13, 15
 sound input and output connectors 17
 stereo miniplug 18, 48, 50
 S-video connector 47, 48
 video connectors 14
conserving energy (Mac OS) 38–40
contrast
 adjusting (Mac OS) 32, 34, 68
 adjusting (Windows) 57
 troubleshooting (Mac OS) 69
contrast controls 5, 7, 32, 57
control buttons
 screen control buttons 5, 7, 32, 57, 90
 sound control buttons 5, 7, 42, 63, 90
control panels (Mac OS)
 ColorSync System Profile control
 panel 85
 Energy Saver control panel 38–40
 Monitors & Sound control panel
 33–35, 43–44
controls on screen
 Mac OS–based computers 34, 44
 Windows-based computers 58–62
Control Strip (Mac OS) 36
convergence, adjusting
 Mac OS–based computers 34, 35
 Windows-based computers 62
Convergence menu (Windows) 62

D

dark screen 68
Default option (Geometry menu,
 Windows) 59
Degauss option (Tools menu,
 Windows) 61
diagonal viewable image size 1
DigitalColor Meter (Mac OS) 36–37
dimensions of the monitor 92
dim screen 68
disconnecting power 2
display cable specifications 94

E

electrical grounding 11
electrical requirements 92
electrical safety precautions 2–3, 11
electromagnetic emissions 3
Energy Saver control panel (Mac OS)
 38–40, 69
environmental features 89
error messages 76–77. *See also*
 troubleshooting
expansion slots 20
exporting ColorSync profile
 (Mac OS) 34
extended miniplug 18
external microphone
 Apple PlainTalk Microphone 18
 choosing with Sound button
 (Mac OS) 34
 connecting to your monitor 19
 as sound input source (Mac OS–based
 computers) 43
 troubleshooting 75
external speakers
 adjusting volume and balance of
 (Mac OS) 34
 as sound output source (Mac OS) 43
eyestrain 68

F

factory preset timings 68, 90–91
flickering screen 69
fuzzy images or text 71

G

gain level, setting (Mac OS) 44
gamma curve setting, changing
 (Mac OS) 34
Geometry button (Monitors & Sound
 control panel, Mac OS) 34, 35
Geometry menu (Windows) 59–60
glare on screen 10
green power indicator light 21
grounded outlet 12
grounding 11

H

- headphone jack 91
- headphones
 - connecting 19
 - as output source (Mac OS–based computers) 43
 - troubleshooting 72, 73, 74
- Height option (Geometry menu, Windows) 59
- help 23. *See also* Monitors & Sound Guide (Mac OS); troubleshooting
- high-density ports, connecting to 14
- Horizontal option (Convergence menu, Windows) 62
- horizontal scan rate 8, 90–91
- Horizontal Shift option (Geometry menu, Windows) 59
- humidity requirements 93

I, J, K

- image options, changing (Mac OS) 34
- importing ColorSync profile (Mac OS) 34
- input electrical requirements 92
- input signals 89
- Installer program (Mac OS–based computers) 26–27
- installing AppleVision software (Mac OS–based computers) 25–28
- interfaces 92
- interference viii, 20
- keyboard
 - connecting to the monitor (Mac OS–based computer) 16
 - microphone button on (Mac OS–based computer) 74

L

- line level input port (Windows-based computers) 17
- location for the monitor 9
- locking the monitor 66

M, N

- Macintosh Guide 23, 28
- Mac OS–based computers
 - adjusting screen images on monitor 32–38
 - adjusting sound on AppleVision 850AV Display 34, 42–44
 - connecting monitor cable to 12–14
 - installing and using AppleVision software on 25–40
 - using on screen controls 34, 44
 - video card for 9
- Mac OS System 7.1, AppleVision software and 30–31
- Mac OS System 7.5 or later, AppleVision software and 28–30
- microphone, built-in (AppleVision 850AV Display)
 - illustration of 5
 - as sound input source (Mac OS–based computers) 43
 - specifications for 91
 - troubleshooting 74
 - turning on and off (Mac OS–based computers) 42
 - turning on and off (Windows-based computers) 63
- microphone, external
 - Apple PlainTalk Microphone 18
 - choosing with Sound button (Mac OS) 34
 - connecting to your monitor 19
 - as sound input source 43
 - troubleshooting 75
- microphone button 5, 19, 42, 63



Can't Find It?

See also **Macintosh Guide's onscreen index.**

Open the Guide (?)

menu and choose

Macintosh Guide

(or Mac OS Guide);

then click the

Index button.

microphone indicator light 5
monitor cable
 connecting to a Mac OS–based computer 12–14
 connecting to a Windows-based computer 15
 connecting to video connectors 14
 illustration of 5, 7
monitor connector 5, 7, 12–13, 15
monitor port
 on a Mac OS–based computer 12–13
 on a Windows-based computer 15
monitors, multiple 20, 34, 44, 69
Monitor Sound button (Monitors & Sound control panel, Mac OS) 34, 44
Monitors & Sound control panel (Mac OS)
 selecting sound options in 43–44
 sound input equipment and 19
 third party driver no longer appears in 75
 troubleshooting 76–79
 working with 33–35
Monitors & Sound Guide (Mac OS) 28–30
mouse, connecting to the monitor (Mac OS–based computer) 16
multiple monitors 20, 34, 44, 69
mute button 5, 42, 63
mute indicator light 5
muting sounds 75
muting speakers
 Mac OS–based computers 42, 74, 75
 Windows-based computers 63

O

off-center images on screen 70
online support 23
onscreen controls
 Mac OS–based computers 34, 44
 Windows-based computers 58–62
overscan
 on Mac OS–based computers 34, 35, 78
 on Windows-based computers 61
Overscan option (Tools menu, Windows) 61

P, Q

Pantone Matching System (Mac OS) 36
picture tube 89
Pincushion option (Geometry menu, Windows) 59
placement of the monitor 9
playing audio CDs (Mac OS–based computers) 52–53
playing sound (Mac OS–based computers) 43
ports
 ADB port 12–13, 16, 20
 composite video ports 45, 46, 47, 48
 high-density ports 14
 line level input port (Windows-based computers) 17
 monitor port 12–13, 15
 sound input and output ports 5, 17, 18, 19, 44
 S-video ports 45, 46, 47, 48
 video port 12
positioning the monitor 10
power
 conserving 89
 disconnecting 2
 troubleshooting 67, 68
power button 5, 7, 21, 32
power cord 5, 7, 12
power indicator light 5, 7, 21, 67, 68
power jumper cord 12
power requirements 92
power strip 12

R

radio interference viii, 20
RCA plugs 47, 48, 50
recalibrating the monitor (Mac OS) 35
recording sound
 Mac OS–based computers 19, 43, 53, 74, 75
 Windows-based computers 19, 74, 75
recording videos (Mac OS–based computers) 45–52
repair 66
resetting the monitor to factory default settings 68

- resolution
 - changing (Mac OS) 34, 36
 - standard 8, 90–91
 - RGB (red, green, blue) values, identifying (Mac OS) 37
 - Rotate option (Geometry menu, Windows) 60
- S**
- safety precautions
 - cleaning screen 1
 - electrical safety 2–3, 11
 - plugging in ADB connector 13
 - plugging in S-video connector 47
 - scan ranges 8
 - Scan Rate option (Tools menu, Windows) 61
 - screen
 - adjusting images on (Mac OS–based computers) 32–38
 - adjusting images on (Windows-based computers) 58–62
 - adjusting to match environment 11
 - blurred or fuzzy images or text on 71
 - cleaning 1, 65–66
 - color problems on 71
 - dark images on 68
 - dark or dim 68
 - flickering 69
 - glare on 10
 - images fail to appear on 68
 - off-center images on 70
 - over- or undersized images on 70
 - resolution of. *See* resolution
 - snow on 71
 - technical information about 89
 - tilted images on 70
 - wavy lines on 71
 - screen controls 32, 57
 - screen geometry, adjusting (Windows) 59–60
 - security lock 66
 - service provider 66
 - setting up the monitor 1–23
 - shielded connector cable 20
 - sleep mode
 - Mac OS–based computers 40
 - Windows-based computers 60, 61
 - snow on screen 71
 - software. *See* AppleVision software
 - software license agreement 26
 - sound
 - adjusting on a Mac OS–based computer 34, 42–44
 - adjusting on a Windows-based computer 63
 - muting 75
 - recording 19, 43
 - troubleshooting 72–75
 - Sound button (Monitors & Sound control panel, Mac OS) 34, 44
 - sound cable 5, 17
 - sound controls on front of AppleVision 850AV Display 42, 63
 - sound controls on screen, (Mac OS) 34, 43–44
 - sound equipment, connecting to your AppleVision 850AV Display 17–19
 - sound input and output connectors 17
 - sound input and output ports 5, 17, 18, 19, 44
 - speakers, built-in (AppleVision 850AV Display)
 - adjusting sound (Mac OS–based computers) 34, 42–44
 - adjusting sound (Windows-based computers) 63
 - energy saver mode and (Mac OS) 40
 - illustration of 4, 5
 - muting (Mac OS–based computers) 42, 74, 75
 - muting (Windows-based computers) 63



Can't Find It?

See also **Macintosh Guide's onscreen index.**

Open the **Guide** (?)

menu and choose

Macintosh Guide

(or **Mac OS Guide**);

then click the

Index button.

- playing audio CDs through (Mac OS-based computers) 52–53
- as sound output source (Mac OS-based computers) 43
- specifications for 91
- troubleshooting 72, 73, 74
- turning on or off in sleep mode (Mac OS) 40
- turning on or off in sleep mode (Windows) 60, 61
- speakers, external
 - adjusting volume and balance of (Mac OS) 34
 - as sound output source (Mac OS-based computers) 43
- specifications 89–95
- standard modes 90
- stereo miniplug 18, 48, 50
- support 23
- S-video connector 47, 48
- S-video format 45
- System 7.1, AppleVision software and 30–31
- System 7.5 or later, AppleVision software and 28–30

T

- technical information 89–95
- technical support 23
- temperature requirements 93
- text, blurred or fuzzy on screen 71
- theft, avoiding 66
- 3D sound
 - specifications for 91
 - turning on and off 44
- tilted images on screen 70
- Tools menu (Windows) 60–61
- treble, setting
 - Mac OS-based computers 42, 44
 - Windows-based computers 63
- treble controls 5, 42, 63

- troubleshooting 23, 66–79
 - alert sound fails 78
 - AppleVision 850AV Display 72–75
 - blank or unreadable screen 71
 - blurred or fuzzy images or text 71
 - brightness 69
 - color 71, 79
 - contrast 68
 - dark images on screen 68
 - dark screen 68
 - dim screen 68
 - error messages 76–77
 - flickering screen 69
 - headphones 72, 73, 74
 - images are too large or too small 70
 - images fail to appear on screen 68
 - microphone 74, 75
 - Monitors & Sound control panel (Mac OS) 76–79
 - off-center images on screen 70
 - overscan 78
 - power 67, 68
 - recording sound 74, 75
 - resolution settings 71, 78
 - screen appearance 68–71
 - snow on screen 71
 - sound (AppleVision 850AV Display) 72–75
 - speakers 72, 73, 74
 - tilted images on screen 70
 - wavy lines on screen 71
 - white point 79
- turning the monitor on 21–22

U

- unplugging the monitor 2
- updating Apple software 23
- user controls, specifications for 90

V

- VCR, connecting to a Mac OS–based computer 48–51
- Vertical option (Convergence menu, Windows) 62
- vertical refresh rate 8, 90–91
- Vertical Shift option (Geometry menu, Windows) 59
- VESA standard modes 8
- VGA adapter 14, 15, 95
- video cable 48, 50
- video card
 - connecting monitor connector to 13
 - determining need for 8–9
- video connectors 14
- video equipment, connecting to a Mac OS–based computer 48–51
- video port 12
- videos, recording (Mac OS–based computers) 45–52
- viewable image size 1
- viewing angle, adjusting 10
- voltage requirements 92
- volume, adjusting
 - Mac OS–based computers 34, 42, 44
 - Windows-based computers 63
- volume controls 5, 34, 42, 63

W, X, Y, Z

- waking up the monitor (Mac OS) 40
- warranty 66
- wavy lines on screen 71
- weight of the monitor 9, 92
- white point
 - setting (Mac OS) 34
 - setting (Windows) 61
 - troubleshooting (Mac OS) 79
- Width option (Geometry menu, Windows) 59
- Windows-based computers
 - adjusting screen images on monitor 58–62
 - adjusting sound on AppleVision 850AV Display 63
 - connecting monitor cable to 15
 - installing AppleVision setup information for Windows 95 operating system 56–57
 - using onscreen controls 58–62
 - using the monitor with 9, 22, 55–63
 - video card for 9
- Windows 95, installing AppleVision setup information for 56–57
- World Wide Web sites provided by Apple Computer 23

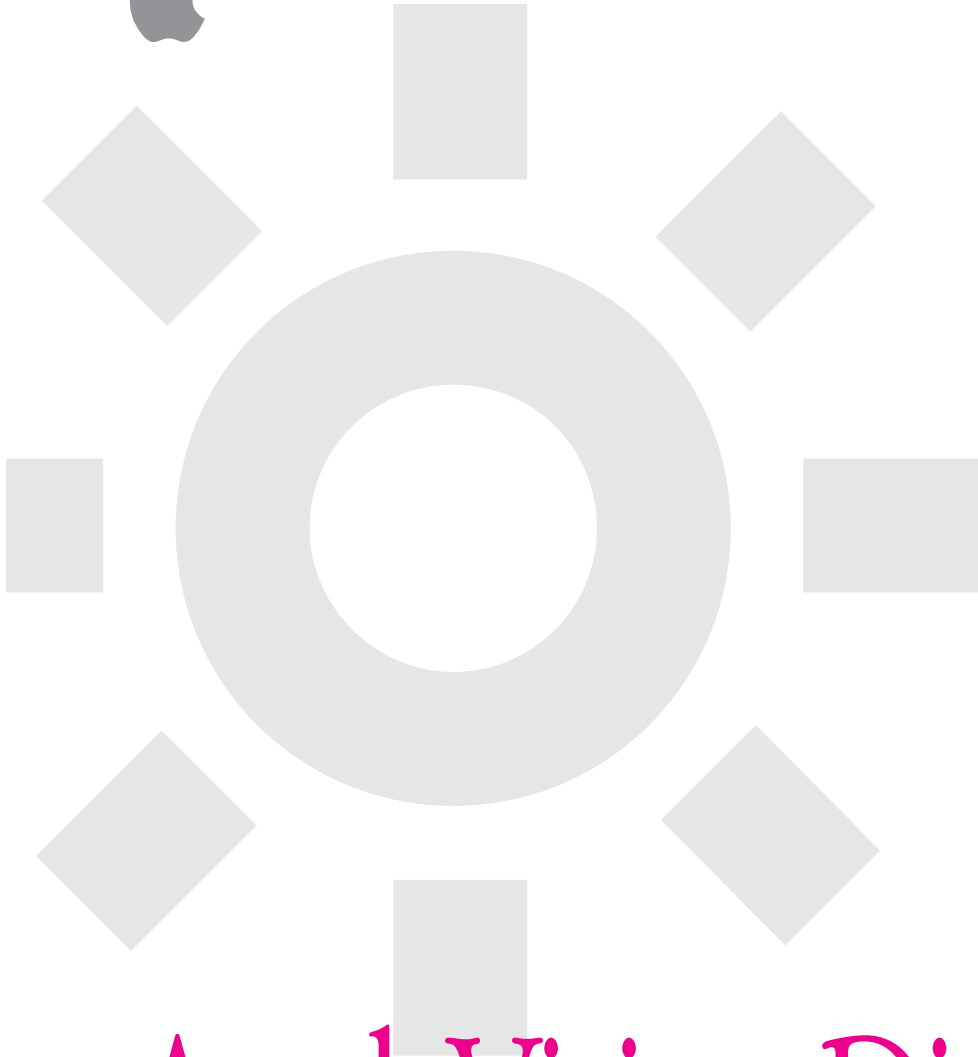

AppleVision Display

User's manual for the AppleVision 850 and 850Av



 Apple Computer, Inc.

© 1997 Apple Computer, Inc. All rights reserved.

Under the copyright laws, this manual may not be copied, in whole or in part, without the written consent of Apple. Your rights to the software are governed by the accompanying software license agreement.

The Apple logo is a trademark of Apple Computer, Inc., registered in the U.S. and other countries. Use of the “keyboard” Apple logo (Option-Shift-K) for commercial purposes without the prior written consent of Apple may constitute trademark infringement and unfair competition in violation of federal and state laws.

Every effort has been made to ensure that the information in this manual is accurate. Apple is not responsible for printing or clerical errors.

Apple Computer, Inc.
1 Infinite Loop
Cupertino, CA 95014-2084
408-996-1010
<http://www.apple.com>

Apple, the Apple logo, AppleCD, AppleVision, ColorSync, the ColorSync logo, LaserWriter, Mac, Macintosh, Performa, PlainTalk, and PowerBook are trademarks of Apple Computer, Inc., registered in the U.S. and other countries.

Finder and OneScanner are trademarks of Apple Computer, Inc.

Adobe, Acrobat, Adobe Illustrator, Photoshop, and PostScript are trademarks of Adobe Systems Incorporated or its subsidiaries and may be registered in certain jurisdictions.

Helvetica and Times are registered trademarks of Linotype-Hell AG and/or its subsidiaries.

NuBus is a trademark of Texas Instruments.

Pantone is a registered trademark of Pantone, Inc.

PowerPC is a trademark of International Business Machines Corporation, used under license therefrom.

Trinitron is a trademark of Sony Corporation, registered in the U.S. and other countries.

Simultaneously published in the United States and Canada.

Mention of third-party products is for informational purposes only and constitutes neither an endorsement nor a recommendation. Apple assumes no responsibility with regard to the performance or use of these products.



Contents



Communications regulation information	viii
1 Setting Up Your Monitor	1
Important safety and cleaning instructions	1
What about electromagnetic emissions?	3
Getting ready to set up your AppleVision 850AV Display	4
Your AppleVision 850AV Display at a glance	5
Getting ready to set up your AppleVision 850 Display	6
Your AppleVision 850 Display at a glance	7
Do you need to install a video card?	8
Mac OS–based computers	9
Windows-based computers	9
Choosing a good location for your monitor	9
Positioning the monitor	10

Connecting the monitor to your computer	11
Connecting the power cord	12
Connecting the monitor cable to a Mac OS–based computer	12
Connecting the monitor cable to a Windows-based computer	15
Connecting a Mac OS–based computer keyboard and mouse to your monitor	16
Connecting sound equipment to your AppleVision 850AV Display	17
Connecting the sound cable	17
Connecting external sound equipment	18
Connecting sound input equipment	19
Connecting sound output equipment	19
Using more than one monitor	20
Turning the monitor on	21
Using the monitor with Windows-based computers	22
Finding answers	23
Obtaining online support and updated Apple software	23
What to do next	24
Mac OS–based computers	24
Windows-based computers	24
2 Installing and Using AppleVision Software	25
Installing AppleVision software	25
Learning about AppleVision software with System 7.5 or later	28
Tips for using Monitors & Sound Guide	29
Learning about AppleVision software with System 7.1	30
Screen controls at a glance	32

About the Monitors & Sound control panel	33
Opening Monitors & Sound	33
Monitors & Sound buttons at a glance	34
Tips for using AppleVision software	35
Using the Control Strip	36
Using DigitalColor Meter	36
Opening DigitalColor Meter	37
Specifying colors using the Pantone Matching System	38
Conserving energy	38
Setting up Energy Saver	39
What happens after you turn on the energy-saving feature?	40
Using Energy Saver with a screen saver	40
3 Using Sound and Video With Your AppleVision 850Av Display	41
Sound controls at a glance	42
About sound sources	43
Sound input sources	43
Sound output sources	43
Selecting sound options in Monitors & Sound	43
Tips for using sound controls	44
Setting up your monitor to record a video with sound	45
About video equipment	45
Using video equipment with your monitor	48
Recording a video	52
Playing an audio CD through the monitor's speakers	52

4	Using Your Monitor With Windows-Based Computers	55
	Installing AppleVision setup information for Windows 95	56
	Screen controls at a glance	57
	Using onscreen controls	58
	Adjusting screen geometry	59
	Adjusting color settings and other features	60
	Adjusting convergence	62
	Adjusting sound on your AppleVision 850AV Display	63
	Tips for using sound controls	63
5	Tips and Troubleshooting	65
	Care and cleaning	65
	Protecting your monitor from theft	66
	Troubleshooting common problems	66
	Monitor power and screen appearance	67
	Sound on your AppleVision 850AV Display	72
	Monitors & Sound control panel for Mac OS–based computers	76
Appendix A	Using ColorSync	81
	The problem that ColorSync solves	81
	How ColorSync works	82
	Setting up ColorSync	84
	Setting the ColorSync System Profile	85
	Setting other ColorSync profiles	86
	Tips for best results	86
Appendix B	Technical Information	89
	Index	97

Communications regulation information

FCC statement

This equipment has been tested and found to comply with the limits for a Class A digital device, pursuant to Part 15 of FCC rules. These limits are designed to provide reasonable protection against radio interference when the equipment is operated in a commercial environment. This equipment generates, uses, and can radiate radio-frequency energy, and if not installed and used in accordance with Apple's instructions, may cause interference to radio communications. Operation of this equipment in a residential area is likely to cause such interference, in which case the user will be required to correct the interference at his or her own expense.

IMPORTANT Changes or modifications to this product not authorized by Apple Computer, Inc., could void the FCC verification and negate your authority to operate the product.

This product was tested for FCC compliance under conditions that included the use of Apple peripheral devices and Apple shielded cables and connectors between system components. It is important that you use Apple peripheral devices and shielded cables and connectors between system components to reduce the possibility of causing interference to radios, television sets, and other electronic devices. You can obtain Apple peripheral devices and the proper shielded cables and connectors through an Apple-authorized dealer. For non-Apple peripheral devices, contact the manufacturer or dealer for assistance.

Industry Canada statement

This Class A device meets all requirements of the Canadian interference-causing equipment regulations.

Cet appareil numérique de la Class A respecte toutes les exigences du Règlement sur le matériel brouilleur du Canada.

CISPR 22 statement

IMPORTANT This is a Class A product. In a domestic environment this product may cause radio interference, in which case the user may be required to take adequate measures.

VCCI Class 1 statement

情報処理装置等電波障害自主規制について

この装置は、第一情報装置（商工業地域において使用されるべき情報装置）で商工業地域での電波障害防止を目的とした情報処理装置等電波障害自主規制協議会（VCCI）基準に適合しております。

従って、住宅地域又はその隣接した地域で使用すると、ラジオ、テレビジョン受信機等に受信障害を与えることがあります。